

Crestron **DMPS-100/200/300-C/300-C-AEC**
DigitalMedia™ Presentation Systems

Operations Guide



Important Safety Instructions

- Read these instructions.
- Keep these instructions.
- Heed all warnings.
- Follow all instructions.
- Do not use this apparatus near water.
- Clean only with dry cloth.
- Do not block any ventilation openings. Install in accordance with the manufacturer's instructions.
- Do not install near any heat sources such as radiators, heat registers, stoves, or other apparatus (including amplifiers) that produce heat.
- Do not defeat the safety purpose of the polarized or grounding-type plug. A polarized plug has two blades with one wider than the other. A grounding-type plug has two blades and a third grounding prong. The wide blade or the third prong are provided for your safety. If the provided plug does not fit into your outlet, consult an electrician for replacement of the obsolete outlet.
- Protect the power cord from being walked on or pinched particularly at plugs, convenience receptacles, and the point where they exit from the apparatus.
- Only use attachments/accessories specified by the manufacturer.
- Use only with the cart, stand, tripod, bracket or table specified by the manufacturer or sold with the apparatus. When a cart is used, use caution when moving the cart/apparatus combination to avoid injury from tip-over. 
- Unplug this apparatus during lightning storms or when unused for long periods of time.
- Refer all servicing to qualified service personnel. Servicing is required when the apparatus has been damaged in any way, such as power-supply cord or plug is damaged, liquid has been spilled or objects have fallen into the apparatus, the apparatus has been exposed to rain or moisture, does not operate normally, or has been dropped.
- Disconnect power prior to connecting or disconnecting equipment.
- Do not install in direct sunlight.
- The apparatus must be installed in a way that the power cord can be removed either from the wall outlet or from the device itself in order to disconnect the mains power.
- Prevent foreign objects from entering the device.

WARNING:

TO REDUCE THE RISK OF FIRE OR ELECTRIC SHOCK, DO NOT EXPOSE THIS APPARATUS TO RAIN OR MOISTURE. THE APPARATUS SHALL NOT BE EXPOSED TO DRIPPING OR SPLASHING. OBJECTS FILLED WITH LIQUIDS, SUCH AS VASES, SHOULD NOT BE PLACED ON THE APPARATUS.

WARNING:

TO PREVENT ELECTRIC SHOCK, DO NOT REMOVE COVER. THERE ARE NO USER SERVICEABLE PARTS INSIDE. ONLY QUALIFIED SERVICE PERSONNEL SHOULD PERFORM SERVICE.



AVIS: RISQUE DE CHOC ELECTRIQUE NE PAS OUVRIR

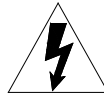

The lightning flash with arrowhead symbol, within an equilateral triangle, is intended to alert the user to the presence of uninsulated "dangerous voltage" within the product's enclosure that may be of sufficient magnitude to constitute a risk of electric shock to persons.

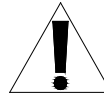

The exclamation point within an equilateral triangle is intended to alert the user to the presence of important operating and maintenance (servicing) instructions in the literature accompanying the appliance.

WARNING:

THIS IS AN APPARATUS WITH CLASS I CONSTRUCTION. IT SHALL BE CONNECTED TO AN ELECTRICAL OUTLET WITH AN EARTHING GROUND TERMINAL.

IMPORTANT:

This device can be used with Class 2 output wiring.

Regulatory Compliance

This product is Listed to applicable UL Standards and requirements by Underwriters Laboratories Inc.



As of the date of manufacture, the DMPS-100/200/300-C/300-C-AEC has been tested and found to comply with specifications for CE marking and standards per EMC and Radiocommunications Compliance Labelling.



Federal Communications Commission (FCC) Compliance Statement

CAUTION: Changes or modifications not expressly approved by the manufacturer responsible for compliance could void the user's authority to operate the equipment.

NOTE: This equipment has been tested and found to comply with the limits for a Class B digital device, pursuant to part 15 of the FCC Rules. These limits are designed to provide reasonable protection against harmful interference in a residential installation. This equipment generates, uses and can radiate radio frequency energy and, if not installed and used in accordance with the instructions, may cause harmful interference to radio communications. However, there is no guarantee that interference will not occur in a particular installation. If this equipment does cause harmful interference to radio or television reception, which can be determined by turning the equipment off and on, the user is encouraged to try to correct the interference by one or more of the following measures:

- Reorient or relocate the receiving antenna
- Increase the separation between the equipment and receiver
- Connect the equipment into an outlet on a circuit different from that to which the receiver is connected
- Consult the dealer or an experienced radio/TV technician for help

Industry Canada (IC) Compliance Statement

CAN ICES-3(B)/NMB-3(B)

The specific patents that cover Crestron products are listed at patents.crestron.com.

Crestron, the Crestron logo, Auto-Locking, Core 3 UI, Cresnet, Crestron Fusion, Crestron e-Control, Crestron Mobile, Crestron Toolbox, DigitalMedia, DigitalMedia 8G, DigitalMedia 8G+, DM, DM 8G+, e-Control, Fusion RV, QuickSwitch HD, and RoomView are either trademarks or registered trademarks of Crestron Electronics, Inc. in the United States and/or other countries. iPad and iPhone are either trademarks or registered trademarks of Apple Inc. in the United States and/or other countries. Blu-ray Disc is either a trademark or registered trademark of the Blu-ray Disc Association (BDA) in the United States and/or other countries. Dolby and Dolby Digital are either trademarks or registered trademarks of Dolby Laboratories in the United States and/or other countries. DTS, DTS-ES, and DTS 96/24 are either trademarks or registered trademarks of DTS Inc. in the United States and other countries. Android is either a trademark or registered trademark of Google Inc. in the United States and/or other countries. HDMI and the HDMI logo are either trademarks or registered trademarks of HDMI Licensing LLC in the United States and/or other countries. Windows is either a trademark or registered trademark of Microsoft Corporation in the United States and/or other countries. HDBaseT and 5Play are either trademarks or registered trademarks of Valens /Semiconductor Ltd. In the United States and/or other countries. Other trademarks, registered trademarks and trade names may be used in this document to refer to either the entities claiming the marks and names or their products. Crestron disclaims any proprietary interest in the marks and names of others. *Crestron is not responsible for errors in typography or photography.*

This document was written by the Technical Publications department at Crestron.
©2013 Crestron Electronics, Inc.

Contents

DigitalMedia Presentation Systems: DMPS-100/200/300-C/300-C-AEC	1
Introduction	1
Features and functions	1
Applications.....	7
Internal Block Diagram	8
Specifications	10
Physical Description	19
Setup	29
Network Wiring.....	29
CAT5 Wiring.....	29
Installation.....	30
Hardware Hookup	32
Uploading and Upgrading.....	36
Establishing Communication.....	36
Firmware	37
IP Configuration	38
DMPS Tool.....	38
Configuration & Operation.....	39
Configuration.....	39
Default System Operation	63
Problem Solving	64
Troubleshooting.....	64
Check Network Wiring.....	66
Reference Documents.....	67
Further Inquiries	67
Future Updates	68
Return and Warranty Policies.....	69
Merchandise Returns / Repair Service	69
Crestron Limited Warranty.....	69

DigitalMedia Presentation Systems: DMPS-100/200/300-C/300-C-AEC

Introduction

The DMPS-100-C, DMPS-200-C, DMPS-300-C, and DMPS-300-C-AEC systems from Crestron® are complete, high-definition presentation control and signal routing solutions for boardrooms, lecture halls, and videoconference rooms. Integrating the control system, multimedia matrix switcher, mic mixer, audio DSP, and amplifier all into one 3-space rack mount package, the systems afford extensive signal routing flexibility and high-performance signal processing without the need for separate components. Auto-configuring inputs enable plug-and-play compatibility with a wide range of digital and analog sources. Built-in DigitalMedia™ and HDBaseT™ connectivity affords a streamlined wiring solution for interfacing with remote AV sources, computers, and display devices.

The DMPS-300-C-AEC is an enhanced version of the DMPS-300-C featuring full-bandwidth acoustic echo cancellation on each of its six mic inputs. It integrates directly with up to two audio or video codecs for a total teleconferencing system solution.

For simplicity within this guide, the term “DMPS-100/200/300-C” is used except where noted.

Features and functions

- High definition multimedia system switcher, mic mixer, audio DSP, amplifier, and control system
- Integrated DigitalMedia switcher featuring DM 8G+™ technology
- Supports HDBaseT Alliance specifications
- Matrix signal routing for up to four sources and one display (DMPS-100-C), six sources and two displays (DMPS-200-C), or seven simultaneous sources and four displays (DMPS-300-C)
- Handles HDMI®, DVI, DisplayPort Multimode, and S/PDIF digital sources
- Handles RGB, composite, S-video, component, and stereo audio analog sources
- Features auto-detecting, auto-switching inputs for all types of video and audio sources
- Includes built-in 2-channel (DMPS-100-C), 4-channel (DMPS-200-C) or 6-channel (DMPS-300-C) gated microphone mixing with DSP

(Continued on following page)

Features and Functions

(Continued)

- Includes full-bandwidth, fully-adaptive acoustic echo cancellation on each mic input (DMPS-300-C-AEC only)
- Allows direct integration with one or two teleconferencing codecs (DMPS-300-C-AEC only)
- Affords versatile audio signal mixing and routing to three (DMPS-100-C), five (DMPS-200-C) or seven (DMPS-300-C) separate outputs
- Allows audio-follow-video or breakaway switching for all inputs
- Enables HDMI audio signal extraction and embedding
- Provides two stereo analog outputs (DMPS 100-C) or three (DMPS-200-C and DMPS-300-C/300-C-AEC), each with independent DSP per output
- Features built-in 40 watt amplifier, selectable for 8 Ω stereo or 70/100 volt mono operation
- Multichannel PCM, Dolby[®], and DTS[®] audio signals can be routed to the HDMI and DM 8G+ outputs
- DigitalMedia 8G+[™] connectivity affords single-wire CAT5e interface for remote sources and displays¹
- Furnishes power over DM[®] or HDBaseT for PoDM/PoH-powered devices²
- QuickSwitch HD[®] technology manages HDCP keys for fast, reliable, switching
- Auto-Locking[™] technology achieves rapid switching between disparate sources
- Performs automatic AV signal format management via EDID
- Scaler options provide discrete image optimization for each display device
- Integrated Ethernet switch provides a single-point LAN connection
- Private Network Mode — requires just two IP addresses for the complete system
- 2-Series control system provides fully-programmable device control
- Supports Crestron touch screens, keypads, and wireless remotes
- Onboard e-Control[®] Web server
- Supports Core 3 UI[™] XPanel Web-based remote control
- Supports Crestron Mobile[®] control apps for iPhone[®], iPad[®] and Android[™]
- Supports Fusion RV[®] and SNMP remote management
- Provides easy setup and diagnostics via front panel or software
- Internal universal power supply for worldwide compatibility
- 3-space 19-inch rack-mountable

1. For DM 8G+ wiring, use Crestron DM-CBL-8G DigitalMedia 8G[™] cable, Crestron DM-CBL DigitalMedia cable, Crestron DM-CBL-D DigitalMedia D cable, or generic CAT5e (or better) UTP or STP. Maximum wire length for DM 8G+ is 330 ft (100 m) between devices. Shielded cable and connectors are recommended to safeguard against unpredictable environmental electrical noise which may impact performance at resolutions above 1080p. Refer to the Crestron DigitalMedia Design Guide (Doc. 4546) for complete system design guidelines. It is available from the Crestron Web site (www.crestron.com/manuals). All wire and cables sold separately.
2. Supplying power over DM (PoDM) or Power over HDBaseT (PoH) requires external power pack, sold separately.

HD System Switcher

The DMPS-100/200/300-C provides high-performance routing of numerous digital and analog sources to up to four separate projectors, flat panel displays, codecs, touch screens, and other devices. Connectivity is provided for multiple HDMI[®] sources¹, or other combinations of HDMI, RGB, S/PDIF, analog audio, and analog video sources (plus additional remote sources via DM 8G+[™]). Input auto-detection and auto-switching eliminates the need to configure the inputs – simply connect the source and the DMPS-100/200/300-C selects the right audio and video combination. Depending on the DMPS device being used, built-in matrix switching allows routing of up to seven simultaneous sources to up to four HDMI or DVI display devices, plus up to three additional analog audio components.

Flexible Audio Routing

The HDMI, S/PDIF, and analog audio inputs may be configured to follow their associated video inputs, or switched independently. In fact, the audio from any HDMI source can be extracted from the digital stream and converted to analog to feed an outboard processor, mixer, or codec, with the return signal feeding back through any analog input, which can be embedded with any video source to form a new HDMI output. Routing of multichannel PCM, Dolby[®], and DTS[®] audio sources is supported through the HDMI and DM 8G+ outputs. All analog audio, HDMI, DM[®], and S/PDIF inputs include adjustable input compensation to accommodate a wide range of signals and maintain consistent volume levels when switching between sources.

DigitalMedia 8G+

Integrated DigitalMedia DM 8G+[™] inputs and outputs afford the ultimate in simplicity, providing a true one-wire interface for remote sources and display devices. Easily add up to two DM 8G+ transmitters to provide connectivity for HD AV sources and computers at a table or lectern. Connect two DM 8G+ receivers (with the DMPS-300-C) to provide independent signal routing and control for two separate projectors or flat panel displays. Supporting wire lengths up to 330 feet (100 meters), DM 8G+ can also provide an ideal interface to a central DigitalMedia switcher as part of a larger multi-room or room-combining system.

DM 8G+ requires just one CAT5e wire run to each location, transporting high-definition video, audio, and Ethernet for each device without compromise. Power over DM (PoDM) is supplied over the same CAT5e connection, providing a centralized power source for all compatible transmitters and receivers.^{2,3}

HDBaseT

Crestron DigitalMedia 8G+ technology is designed using HDBaseT Alliance specifications, ensuring interoperability with third-party HDBaseT products. Via DM 8G+, the DMPS-100/200/300-C can be connected directly to any HDBaseT compliant source or display device without requiring a DM transmitter or receiver.

1. HDMI requires an appropriate adapter or interface cable to accommodate a DVI or DisplayPort Multimode signal. CBL-HD-DVI interface cables available separately.
2. For DM 8G+ wiring up to 330 ft (100 m) between devices, use Crestron DM-CBL-8G DigitalMedia 8G cable, Crestron DM-CBL DigitalMedia cable, Crestron DM-CBL-D DigitalMedia D cable, or generic CAT5e (or better) UTP or STP. Shielded cable and connectors are recommended to safeguard against unpredictable environmental electrical noise which may impact performance at resolutions above 1080p. Refer to the Crestron DigitalMedia Design Guide (Doc. 4546) for complete system design guidelines. All cable sold separately.
3. Supplying power over DM (PoDM) requires external power pack, sold separately.

The DMPS-100/200/300-C supports 5Play™, the feature set of HDBaseT that converges uncompressed full HD digital video, audio, Ethernet*, power and control signals through a single CAT5e or CAT6 cable over distances up to 328 ft (100m).

Multi-Channel Microphone Mixer

For a complete presentation or conferencing solution, the DMPS-100/200/300-C includes built-in mixing and processing for multiple microphones (two for DMPS-100-C, four for DMPS-200-C, six for DMPS-300-C/300-C-AEC). Each mic input provides selectable mic or line level with 40 dB gain adjustment, switchable 48V phantom power, fully-adjustable gating, compression, limiting, and 4-band EQ. Sophisticated matrix mixing allows for a completely different stereo mix of all microphones at each of the DMPS-100/200/300-C system's outputs.

Acoustic Echo Cancellation (DMPS-300-C-AEC Only)

High-performance adaptive AEC on each mic input enables the DMPS-300-C-AEC to be connected directly to audio and video codecs to form a complete teleconferencing system solution. Low-latency, full-bandwidth performance affords highly-effective echo cancellation with natural sound quality. AEC is employed independently per microphone, with a fast convergence rate of 80 dB per second and tail lengths up to 200 ms, allowing the DMPS-300-C-AEC to handle any typical small to medium sized room with ease.

Expanded signal routing and audio processing in the DMPS-300-C-AEC allows one or two codecs to be connected to any of the seven source inputs, and either (or both) of the aux outputs. Dual codec support allows both codecs to be used simultaneously, even allowing the signal from one codec to be fed to the other for a fully inclusive teleconferencing experience. Plus, any local presentation source can be mixed with the microphones and routed to the codecs, allowing far end participants to experience the full presentation without any distracting echo.

Professional Audio DSP

Each analog audio output on the DMPS-100/200/300-C includes its own digital signal processor, allowing each output to be optimized to feed a power amplifier, codec, recorder, or assistive listening system. In addition to real-time adjustable volume, bass, treble, and mute controls, each DSP provides 10-band graphic equalization, 2-band parametric equalization, and 85 ms speaker delay adjustment. Hardware relay muting on each output helps prevent "thumping" on power up.

An additional dedicated DSP is included to process the AEC reference signal inside the DMPS-300-C-AEC, allowing its EQ and volume level to be set to track that of the main program output feeding the room speakers. In some situations, this can reduce the demand on the AEC's adaptive filter for even more transparent performance.

Built-in Amplifier

Its built-in 40 watt amplifier allows the DMPS-100/200/300-C to directly drive a pair of stereo speakers, or a string of 70 or 100 volt ceiling speakers. Fed by the main "Program" output, the internal amplifier benefits fully from the onboard DSP. For larger applications, Crestron AMP-Series power amplifiers may be added, providing a complete solution for driving separate program and speech speakers, or any multi-zone loudspeaker system.

* Supplying power over DM (PoDM) requires external power pack, sold separately.

EDID Format Management

The DMPS-100/200/300-C allows for management of the EDID (Extended Display Identification Data) information that passes between the display devices and input sources in the system. Using Crestron Toolbox™ software, the format and resolution capabilities of each device can be assessed, allowing the installer to configure EDID signals appropriately for the most desirable and predictable behavior.

A Scaler for Every Display

Through a distributed scaler approach, the DMPS-100/200/300-C affords a very flexible and user-friendly solution for handling multiple disparate display devices and video codecs. Employing discrete outboard scalers like the HD-SCALER and DM-RMC-SCALER-C (both sold separately), the DMPS-100/200/300-C allows an independent high-performance scaler to be installed at every display device, and in front of each codec, ensuring an optimal image on every screen no matter what sources are selected.

QuickSwitch HD Technology

Handling high definition digital media means handling HDCP (High-bandwidth Digital Content Protection), the encryption scheme used by content providers to protect their DVDs and Blu-ray Disc™ releases and broadcast signals against unauthorized copying. Viewing HDCP encrypted content requires a source device to "authenticate" each display and signal processor in the system and issue it a "key" before delivering an output signal.

Using a conventional HDMI or DVI switcher, it is common to experience a complete loss of signal for up to 15 seconds during the authentication process each time a new source or display is selected anywhere in the system. Also, every source device has a limited number of keys available, so connect too many displays and the source simply stops outputting a signal without warning.

Crestron QuickSwitch HD® manages the keys for every HDCP-compliant device in the system, maintaining continuous authentication for each device to ensure fast, reliable routing of any source to any number of display devices.

Auto-Locking Technology

Crestron Auto-Locking™ Technology enables super fast signal switching by instantaneously configuring every device in the signal path, including DM transmitters, DM receivers, and scalers, as soon as the signal hits the first device. Whether switching between sources or TV channels, Auto-Locking significantly reduces the time it takes each device to sense the new signal and configure itself to handle the changes, virtually eliminating any noticeable gap while switching.

Built-in Ethernet Switch

In addition to transporting digital video and audio, the DigitalMedia 8G+ ports on the DMPS-100/200/300-C can also extend Ethernet out to each display and source device, providing high-speed connectivity for each room device that requires a LAN connection. Ethernet is also utilized internally by the Crestron control bus to manage each transmitter and receiver and provide device control.

Private Network Mode

To streamline its implementation on a corporate or university LAN, the DMPS-100/200/300-C employs *Private Network* mode to provide a single-point connection for the complete system. Using *Private Network* mode, the

DMPS-100/200/300-C requires just one IP address for the complete DM network, plus one additional IP address for the built-in control processor.

Integrated Control System

Its built-in 2-Series control system enables the DMPS-100/200/300-C to provide complete, customizable control of every AV device, as well as room lighting, window shades, and projection screens, without requiring a separate control processor. The DMPS-100/200/300-C supports the full line of Crestron touch screens, keypads, and wireless remotes for a user experience custom tailored to the specific requirements of each end-user. Support for Crestron e-Control[®], Crestron Mobile[®], Fusion RV[®], and RoomView[®] applications delivers the industry's most powerful platform for attaining remote access and centralized management using computers and mobile devices.

CEC Embedded Device Control

The primary objective of every Crestron system is to enable precisely the control desired for a seamless user experience. In addition to conventional IR, RS-232, and Ethernet device control, the DMPS-100/200/300-C can provide an additional alternative by harnessing the CEC (Consumer Electronics Control) signal embedded in HDMI. The DMPS-100/200/300-C provides a gateway for controlling many devices right through their HDMI connections, potentially eliminating the need for any dedicated control wires or IR probes. Through proper CEC signal management, the DMPS-100/200/300-C permits control of each device as desired.

Easy Setup

Every step of the DMPS-100/200/300-C setup process is designed to be quick and easy using its front panel or Crestron Toolbox software, configuring inputs and outputs automatically while letting the installer make intelligent design decisions along the way. Out of the box, the DMPS-100/200/300-C's front panel supports basic signal routing for easy testing and troubleshooting during installation. The front panel label strips can be customized using Crestron Engraver software or standard 3/8" (~10 mm) tape labels, allowing for the clear designation of each input and output. Inputs and outputs may also be designated by name through the software to appear on the LCD display.

Applications

The following Applications diagram shows a DMPS-300-C in a Video Conferencing application.

DMPS-300-C in a Video Conferencing Application

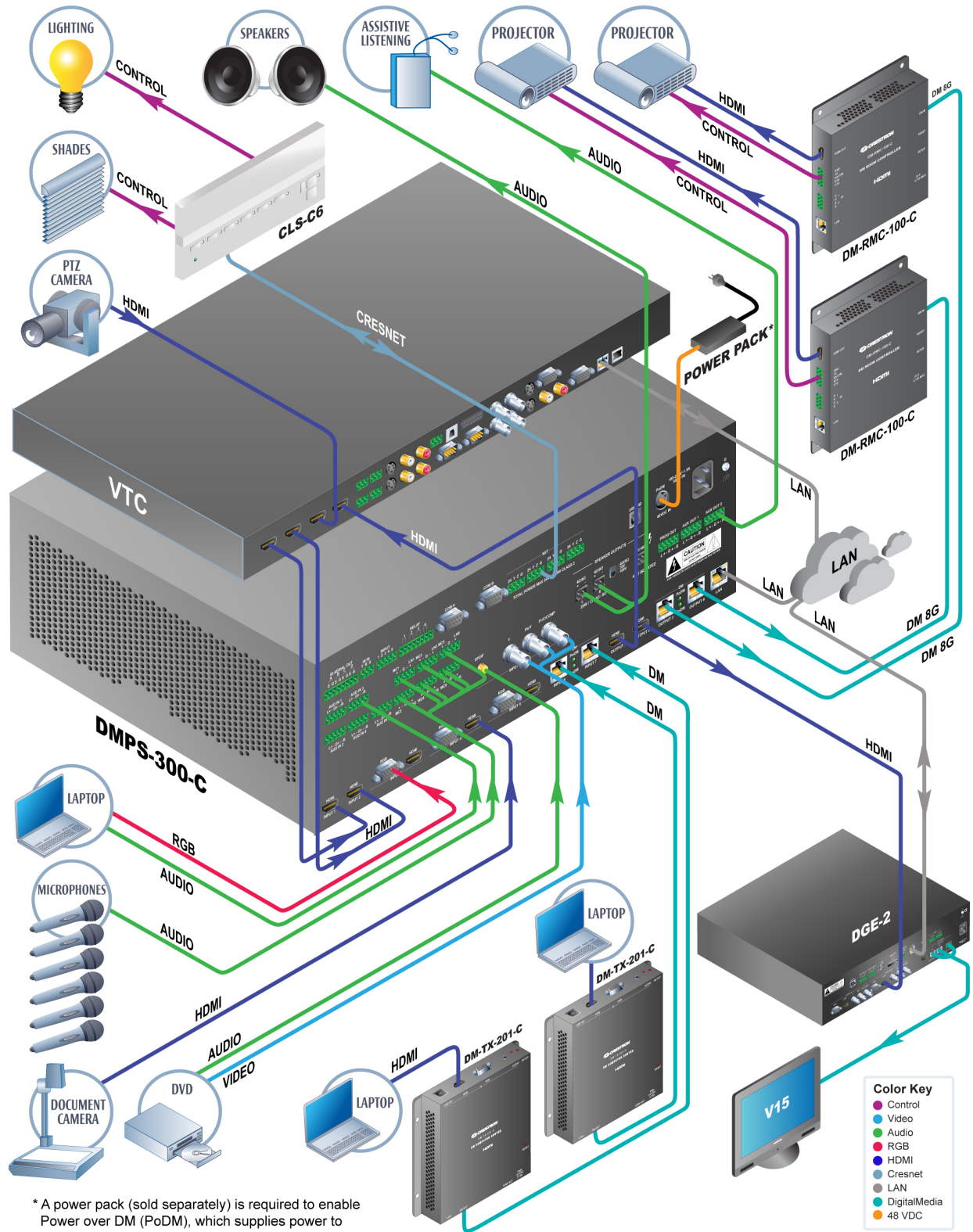

* A power pack (sold separately) is required to enable Power over DM (PoDM), which supplies power to PoDM compatible DM 8G+ Transmitters and Receivers.

Internal Block Diagram

The following diagrams represent the audio and video switching functions of the DMPS-300-C and the DMPS-300-C-AEC.

DMPS-300-C Audio Block Diagram

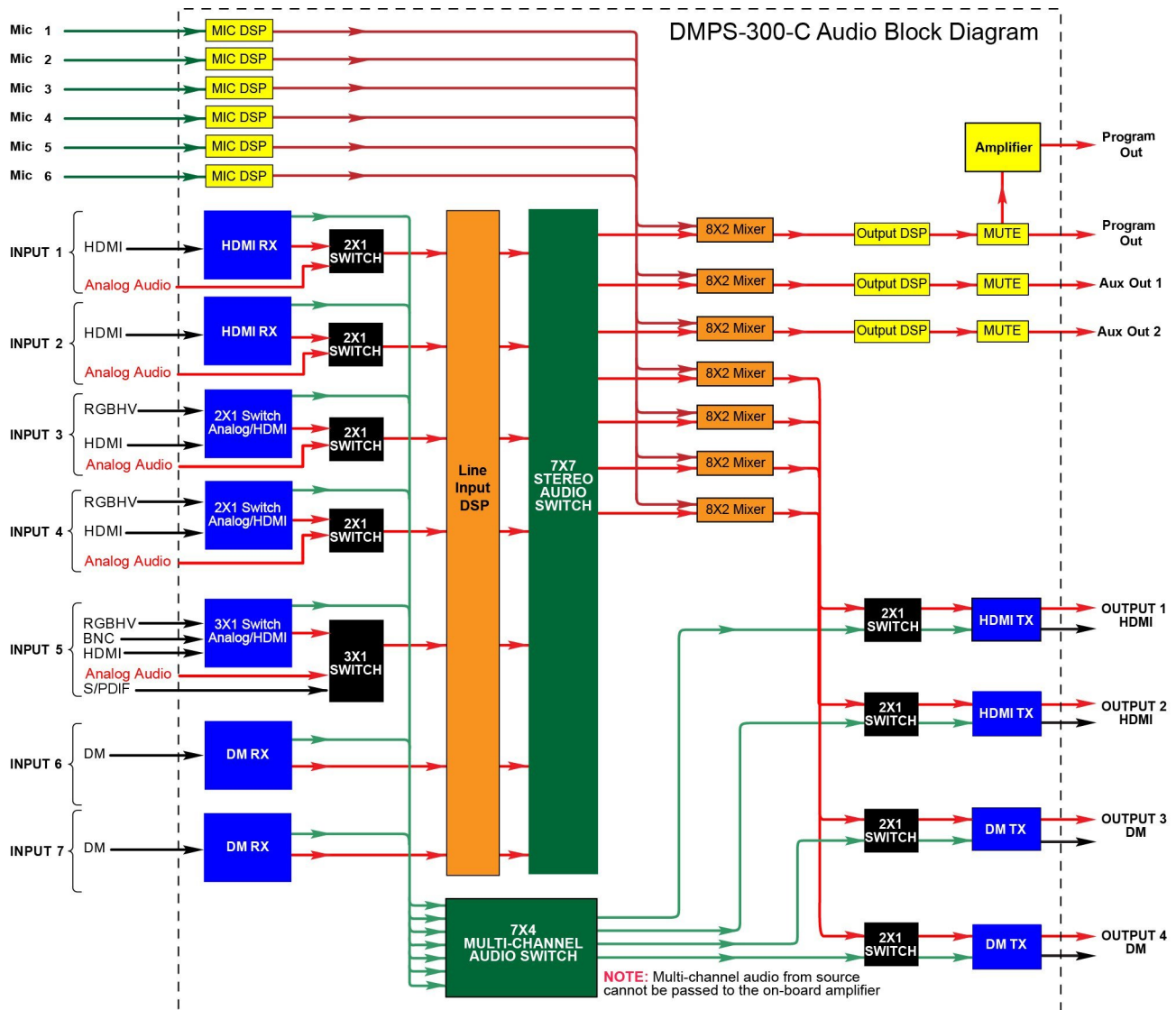

DMPS-300-C-AEC Audio Block Diagram

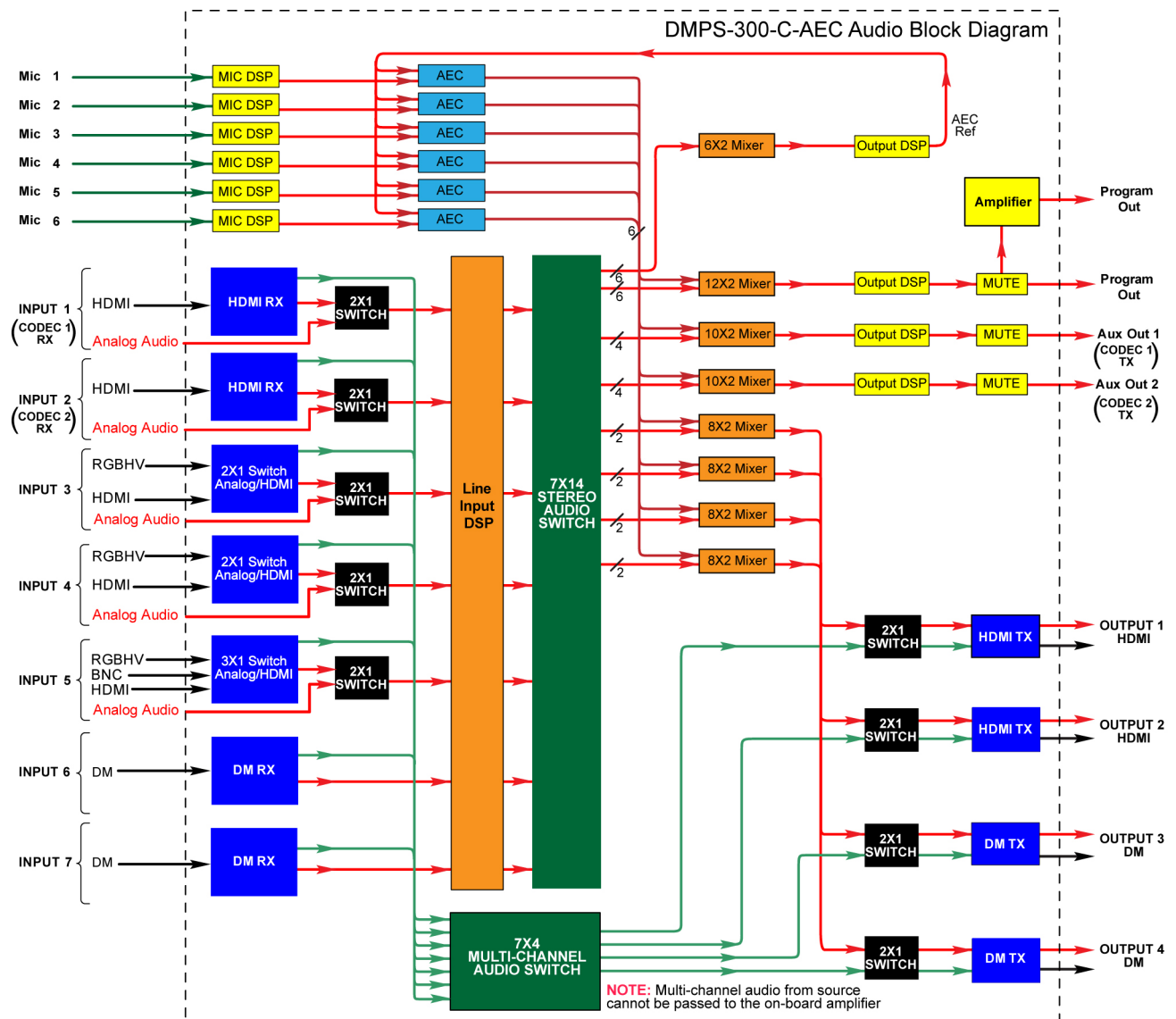

DMPS-300-C Video Block Diagram

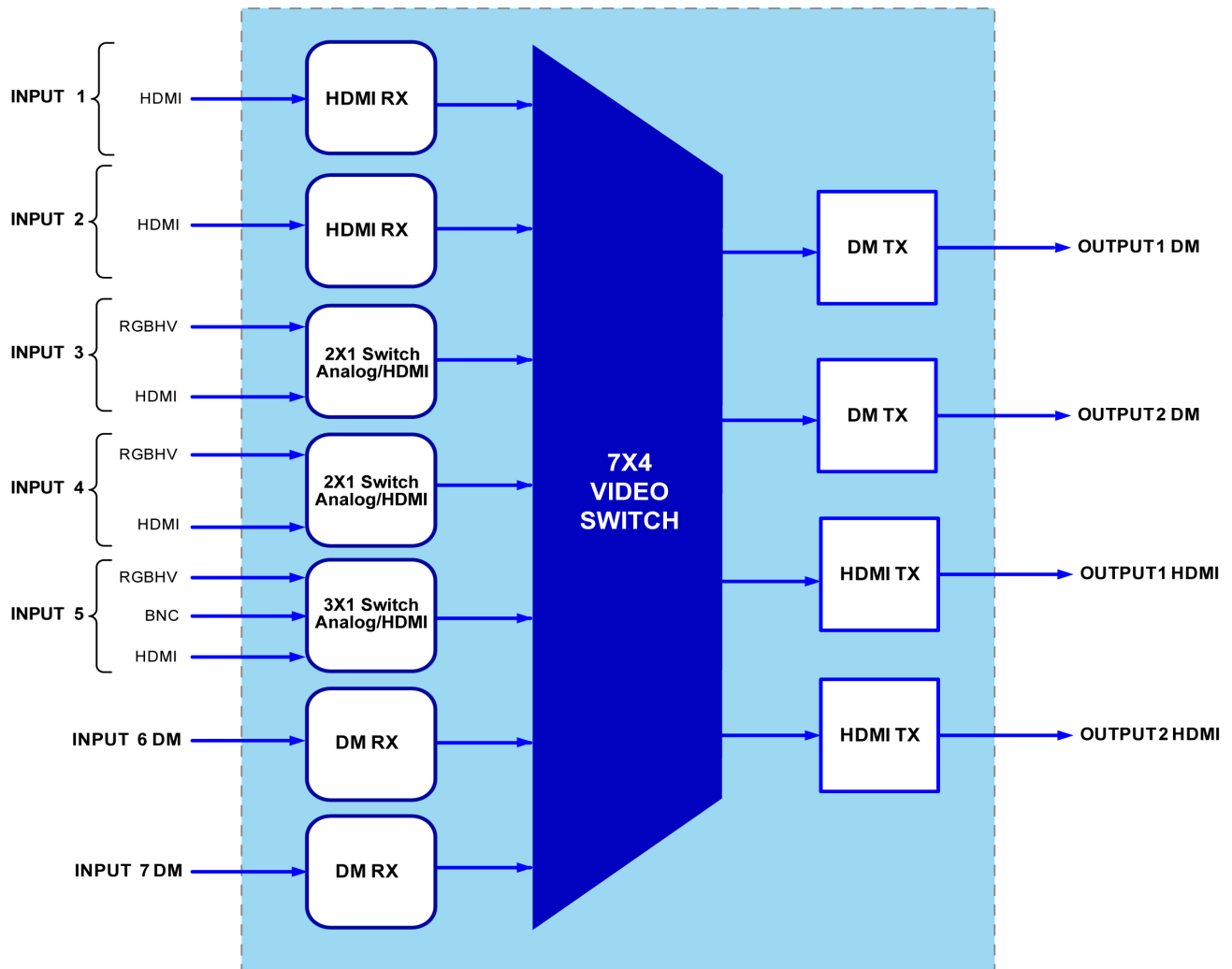

Specifications

Specifications for the DMPS-100/200/300-C are listed in the following table.

NOTE: In the following table, references to AEC controls and specifications are relevant only to the DMPS-300-C-AEC.

DMPS-100/200/300-C Specifications

SPECIFICATION	DETAILS
Operating System	Crestron 2-Series; real-time, preemptive, multi-threaded/multitasking kernel; FAT32 file system with long names
Memory	
SDRAM:	32 MB
NVRAM:	256 kB
Flash:	16 MB

(Continued on following page)

DMPS-100/200/300-C Specifications (Continued)

SPECIFICATION	DETAILS
Communications	
Ethernet	10/100/1000 Mbps, auto-switching, auto-negotiating, auto-discovery, full/half duplex, TCP/IP, UDP/IP, CIP, DHCP, <i>Private Network</i> mode, SSL, SNMP, IPv4, RSTP, SMTP e-mail client, Web Server; Installer setup via Crestron Toolbox; Supports all e-Control [®] , Crestron Mobile, Fusion RV and RoomView applications
Cresnet [®]	Cresnet master mode
DigitalMedia	DM 8G+, HDCP, EDID, CEC, PoDM, HDBaseT compliant
HDMI	HDMI, HDCP, EDID, CEC
USB	USB service port for computer console, USB HID signal routing over DM
RS-232	2-way device control and monitoring up to 115.2k baud with hardware and software handshaking
IR/Serial	1-way device control via infrared up to 1.2 MHz, or serial TTL/RS-232 (0-5 volts) up to 115.2k baud; supports CNXRMI RD IR Receiver ¹
Ethernet Switch	Multi-port switch with <i>Private Network</i> mode; Provides (1) onboard 10/100/1000BASE-T Gigabit Ethernet port, and multiple remote 10BASE-T/100BASE-TX Ethernet ports via select outboard DM devices, plus internal Ethernet ports for the control processor, switcher, and audio DSP
Video	
Switcher	Auto-detecting multi-format digital/analog source inputs, 7x4 matrix switcher, HDMI and DM 8G+ outputs, QuickSwitch HD technology
Input Signal Types (DMPS-100-C)	HDMI (Inputs 1-4), RGB ² (Inputs 2-4), composite/S-video/component (Input 4)
Input Signal Types (DMPS-200-C)	HDMI (Inputs 1-5), RGB ² (Inputs 3-5), composite/S-video/component (Input 5), DM 8G+ (Input 6)
Input Signal Types (DMPS-300-C)	HDMI (Inputs 1-5), RGB ² (Inputs 3-5), composite/S-video/component (Input 5), DM 8G+ (Inputs 6 & 7)
Output Signal Types (DMPS-100-C)	HDMI , DM 8G+ (Output 1)
Output Signal Types (DMPS-200-C)	HDMI (Output 1), DM 8G+ (Output 2)
Output Signal Types (DMPS-300-C)	HDMI (Outputs 1 & 2), DM 8G+ (Outputs 3 & 4)

(Continued on following page)

DMPS-100/200/300-C Specifications (Continued)

SPECIFICATION	DETAILS
Video (Continued)	
Formats	HDMI with Deep Color & 3D ³ , DVI ⁴ , DisplayPort Multimode ⁴ , HDCP content protection support, HD up to 1080i/1080p, computer up to UXGA/WUXGA, RGBHV, RGBS, RGsB, YPbPr, Y/C, NTSC, PAL
Input Resolutions HDMI & HDBaseT, Progressive	640 x 480 @ 60 Hz 720 x 480 @ 60 Hz (480p) 720 x 576 @ 50 Hz (576p) 800 x 600 @ 60 Hz 848 x 480 @ 60 Hz 852 x 480 @ 60 Hz 854 x 480 @ 60 Hz 1024 x 768 @ 60 Hz 1024 x 852 @ 60 Hz 1024 x 1024 @ 60 Hz 1280 x 720 @ 50 Hz (720p50) 1280 x 720 @ 60 Hz (720p60) 1280 x 768 @ 60 Hz 1280 x 800 @ 60 Hz 1280 x 960 @ 60 Hz 1280 x 1024 @ 60 Hz 1360 x 768 @ 60 Hz 1365 x 1024 @ 60 Hz 1366 x 768 @ 60 Hz 1400 x 1050 @ 60 Hz 1440 x 900 @ 60 Hz 1600 x 900 @ 60 Hz 1600 x 1200 @ 60 Hz 1680 x 1050 @ 60 Hz 1920 x 1080 @ 24 Hz (1080p24) 1920 x 1080 @ 25 Hz (1080p25) 1920 x 1080 @ 50 Hz (1080p50) 1920 x 1080 @ 60 Hz (1080p60) 1920 x 1200 @ 60 Hz 2048 x 1080 @ 24 Hz 2048 x 1152 @ 60 Hz plus any other resolution allowed by HDMI up to 165M Hz pixel clock
Input Resolutions HDMI & HDBaseT, Interlaced	720 x 480 @ 30 Hz (480i) 720 x 576 @ 25 Hz (576i) 1920 x 1080 @ 25 Hz (1080i25) 1920 x 1080 @ 30 Hz (1080i30) plus any other resolution allowed by HDMI up to 165 MHz pixel clock
Input Resolutions RGB	640 x 480 @ 60 Hz 720 x 480 @ 60 Hz (480p) 720 x 576 @ 50 Hz (576p) 800 x 600 @ 60 Hz 848 x 480 @ 60 Hz 1024 x 768 @ 60 Hz 1280 x 720 @ 50 Hz (720p50) 1280 x 720 @ 60 Hz (720p60) 1280 x 768 @ 60 Hz 1280 x 800 @ 60 Hz

(Continued on following page)

DMPS-100/200/300-C Specifications (Continued)

SPECIFICATION	DETAILS
Video	
Input Resolutions RGB (Continued)	1280 x 960 @ 60 Hz 1280 x 1024 @ 60 Hz 1360 x 768 @ 60 Hz 1366 x 768 @ 60 Hz 1400 x 1050 @ 60 Hz 1440 x 900 @ 60 Hz 1600 x 1200 @ 60 Hz 1680 x 1050 @ 60 Hz 1920 x 1080 @ 50 Hz (1080p50) 1920 x 1080 @ 60 Hz (1080p60) 1920 x 1200 @ 60 Hz 2048 x 1152 @ 60 Hz
Input Resolutions Component	480i, 576i, 480p, 576p, 720p50, 720p60, 1080p24, 1080i25 (1125 lines), 1080i30, 1080p30, 1080p50 (1125 lines), 1080p60
Input Resolutions Composite and S-video	480i, 576i
Output Resolutions	Matched to inputs
Analog-To-Digital Conversion	10-bit 165 MHz per each of 3 channels
Audio	
Switcher/Mixer (DMPS-100-C)	2-channel gated mic mixer with DSP, auto-detecting multi-format digital/analog source inputs, 4 x 3 stereo source switcher, 4 x 1 multi-channel source switcher, analog and HDMI outputs, DM 8G+ outputs, independent 2-channel mic + source mixer per output, independent stereo DSP per analog output, integrated power amplifier, digital audio pass-through mode
Switcher/Mixer (DMPS-200-C)	4-channel gated mic mixer with DSP, auto-detecting multi-format digital/analog source inputs, DigitalMedia 8G+ inputs, 6 x 5 stereo source switcher, 6 x 2 multi-channel source switcher, analog and HDMI outputs, DM 8G+ outputs, independent 4-channel mic + source mixer per output, independent stereo DSP per analog output, integrated power amplifier, digital audio pass-through mode
Switcher/Mixer (DMPS-300-C)	6-channel gated mic mixer with DSP, auto-detecting multi-format digital/analog source inputs, DigitalMedia 8G+ inputs, 7 x 7 stereo source switcher, 7 x 4 multi-channel source switcher, analog and HDMI outputs, DM 8G+ outputs, independent 6-channel mic + source mixer per output, independent stereo DSP per analog output, integrated power amplifier, digital audio pass-through mode

(Continued on following page)

DMPS-100/200/300-C Specifications (Continued)

SPECIFICATION	DETAILS
Audio (Continued)	
Switcher/Mixer (DMPS-300-C-AEC)	6-channel gated mic mixer with DSP and AEC, auto-detecting multi-format digital/analog source inputs, DigitalMedia 8G+ /HDBaseT inputs, 7 x 14 stereo source switcher, 7 x 4 multi-channel source switcher, analog and HDMI outputs, DM 8G+ outputs, independent 6-channel mic + source mixer per output, independent stereo DSP per analog output, dedicated AEC reference mixer and DSP, integrated power amplifier, digital audio pass-through mode
Typical of microphone input channels:	
Input Signal Types	Mono analog mic or line level
Analog-To-Digital Conversion	24-bit 48 kHz
Phantom Power	Enable/Disable per channel
Gain	+12 to +57 dB (mic level), adjustable from 0% to 100%, plus mute
Delay	0.0 to 85.3 ms
EQ Center Frequencies	160, 500, 1.2k, 3k Hz
EQ Gain	±12.0 dB per band
Gating Level (Threshold)	-80 to 0 dB
Gating Depth (Attenuation)	-80 to 0 dB
Gating Attack	1 to 250 ms
Gating Decay (Release)	1 to 1000 ms
Compression Level (Threshold)	-80 to 0 dB
Compression Ratio	1:1 to 10:1
Compression Attack	1 to 250 ms
Compression Release	1 to 1000 ms
Compression Curve	Hard or soft knee
Limiting Level (Threshold)	-80 to 0 dB
Limiting Attack	1 to 250 ms
Limiting Release	1 to 1000 ms
Limiting Curve	Hard or soft knee
AEC:	Enable/Disable
AEC High-Pass Filter	Enable/Disable at 80 Hz
AEC Double-Talk Suppression	0.0 to -50.0 dB
AEC Noise Cancellation	0.0 to -50.0 dB
AEC Automatic Gain Control	0.0 to -50.0 dB, plus disable

(Continued on following page)

DMPS-100/200/300-C Specifications (Continued)

SPECIFICATION	DETAILS
Audio	
Typical of microphone input channels (Continued)	
AEC Bandwidth	20 Hz to 24 kHz
AEC Convergence Rate	80 dB/sec
AEC Tail Length	200 ms
Typical of source input channels:	
Input Signal Types (DMPS-100-C)	HDMI or DisplayPort Multimode ⁴ (Inputs 1-4), analog 2-Channel (Inputs 1-4), S/PDIF (Input 4)
Input Signal Types (DMPS-200-C)	HDMI or DisplayPort Multimode ⁴ (Inputs 1-5), analog 2-Channel (Inputs 1-5), S/PDIF (Input 5), DM 8G+ (Inputs 6)
Input Signal Types (DMPS-300-C/-AEC)	HDMI or DisplayPort Multimode ⁴ (Inputs 1-5), analog 2-Channel (Inputs 1-5), S/PDIF (Input 5), DM 8G+ (Inputs 6 & 7)
Formats, Analog	Stereo 2-channel
Formats, HDMI & DM (No DM on DMPS-100-C)	Dolby Digital [®] , Dolby Digital EX, DTS, DTS-ES [®] , DTS 96/24 [®] , up to 8-channel PCM
Formats, S/PDIF	2-channel PCM
Analog-To-Digital Conversion	24-bit 48 kHz
Input Compensation	±10 dB
Typical of analog line outputs with DSP:	
Output Signal Type/Format	Stereo 2-channel
Digital-To-Analog Conversion	24-bit 48 kHz
Volume	-80 to +20 dB, adjustable from 0% to 100%, plus mute
Bass	±12.0 dB
Treble	±12.0 dB
Mic Mix Gain (per mic input)	-80.0 to 0.0 dB, plus mute and balance
Source Mix Gain	-80.0 to 0.0 dB, plus mute and balance
Codec Mix Gain (x2 on Program Out, x1 on each Aux Out):	-80.0 to 0.0 dB, plus mute and balance
Mixer Presets	1 thru 5
Equalization	10-band graphic + 2-band parametric
GEQ Center Frequencies	31.5, 63, 125, 250, 500, 1k, 2k, 4k, 8k, 16k Hz
GEQ Gain	±12.0 dB per band

(Continued on following page)

DMPS-100/200/300-C Specifications (Continued)

SPECIFICATION	DETAILS
Audio	
Typical of analog line outputs with DSP: (Continued)	
GEQ Presets	1 thru 10
PEQ Center Frequencies	5 to 24,000 Hz per band
PEQ Gain	-36.0 to +24.0 dB per band
PEQ Bandwidth	0.02 to 3.50 octaves per band
PEQ Types	Peaking EQ, High Pass, Low Pass, High Shelf, Low Shelf, Notch
Delay	0.0 to 85.3 ms
Frequency Response	20 Hz to 20 kHz \pm 0.5 dB (digital source), 20 Hz to 20 kHz \pm 0.5 dB (analog line source), 20 Hz to 20 kHz \pm 0.7 dB (microphone source)
S/N Ratio	>108 dB (digital source), >103 dB (analog line source), 1 kHz, A-weighted
THD+N	<0.002% (digital source), <0.005% (analog line source), <0.05% (microphone source), 20 Hz to 20 kHz
Stereo Separation	>108 dB (digital source) >103 dB (analog source)
Channel Separation	>103 dB
AEC reference output (internal):	
Volume	-80 to +20 dB, adjustable from 0% to 100%, plus mute
Bass	\pm 12.0 dB
Treble	\pm 12.0 dB
Source Mix Gain	-80.0 to 0.0 dB, plus mute and balance
Codec Mix Gain (x2)	-80.0 to 0.0 dB, plus mute and balance
Equalization	10-band graphic + 2-band parametric
GEQ Center Frequencies	31.5, 63, 125, 250, 500, 1k, 2k, 4k, 8k, 16k Hz
GEQ Gain	\pm 12.0 dB per band
GEQ Presets	1 thru 10
PEQ Center Frequencies	5 to 24000 Hz per band
PEQ Gain	-36.0 to +24.0 dB per band
PEQ Bandwidth	0.02 to 3.50 octaves per band
PEQ Types	Peaking EQ, High Pass, Low Pass, High Shelf, Low Shelf, Notch
Typical of HDMI/DM outputs:	
Output Signal Types	HDMI (Outputs 1 & 2), DM 8G+/HDBaseT (Outputs 3 & 4)
Formats	Dolby Digital, Dolby Digital EX, DTS, DTS-ES, DTS 96/24, up to 8-channel PCM

(Continued on following page)

DMPS-100/200/300-C Specifications (Continued)

SPECIFICATION	DETAILS
Audio	
Typical of HDMI/DM outputs: (Continued)	
Volume	-80.0 to +20.0 dB, adjustable from 0% to 100%, plus mute ⁵
Mic Mix Gain Range (x6)	-80.0 to 0.0 dB, plus mute ⁵
Mic Balance (x6)	0dB to -80dB, either channel from center ⁵
Source Mix Gain	Peaking EQ, High Pass, Low Pass, High Shelf, Low Shelf, Notch
Frequency Response	20 Hz to 20 kHz ±0.5 dB (digital source), 20 Hz to 20 kHz ±0.5 dB (analog line source), 20 Hz to 20 kHz ±0.7 dB (microphone source)
S/N Ratio	>108 dB (digital source), >103 dB (analog line source), 1 kHz, A-weighted
THD+N	<0.002% (digital source), <0.005% (analog line source), <0.05% (microphone source), 20 Hz to 20 kHz
Stereo Separation	>108 dB (digital source) >103 dB (analog source)
Channel Separation	>108 dB (digital source), >103 dB (analog source)
Stereo Amplified Output (same signal as Program output):	
Output Power, 4/8 Ω	20 watts RMS per channel at 8 Ω, 4 Ω tolerant
Output Power, 70/100V	40 watts RMS
Frequency Response	20 Hz to 20 kHz ±1 dB @ 20 watts into 8 Ω 100 Hz to 20 kHz ±2.5 dB @ 70 or 100 volts
S/N Ratio	98 dB @ 20 watts into 8 Ω, 96 dB @ 20 watts into 4 Ω, 1 kHz, A-weighted
THD+N	<0.1% (1 kHz), <0.7% (20 Hz to 20 kHz) @ 20 watts into 4 or 8 Ω
Stereo Separation	>65 dB @ 20 watts, 1 kHz
Power Requirements	
Main Power	4 amps @ 100-240 volts ac, 50/60 Hz
Available Cresnet Power	30 watts
Power over DM	1.875 amps @ 48 volts (100-240 volts ac, 50/60 Hz power pack, sold separately)
Environmental	
Temperature	41° to 104° F (5° to 40° C)
Humidity	10% to 90% RH (non-condensing)
Heat Dissipation	277 BTU/hr
Enclosure	
Chassis	Metal, black finish, fan-cooled, vented sides

(Continued on following page)

DMPS-100/200/300-C Specifications (Continued)

SPECIFICATION	DETAILS
Enclosure (Continued)	
Faceplate	Metal, black finish with polycarbonate label overlay
Mounting	Freestanding or 3U 19-inch rack-mountable (adhesive feet and rack ears included)
Dimensions	
Height	5.20 in (133 mm) without feet
Width	17.28 in (439 mm); 19.00 in (483 mm) with rack ears
Depth	16.31 in (415 mm)
Weight	
DMPS-100-C	16.3 lb (7.4 kg)
DMPS-200-C	16.4 lb (7.5 kg)
DMPS-300-C	22.0 lb (9.9 kg)
Available Accessories	
AMP-Series	Commercial Amplifiers
CBL Series	Crestron Certified Interface Cables
CNSP-XX	Custom Serial Interface Cable
CNXRMIRD	IR Receiver
CRESNET	Cresnet Control Cable
DM-8G-CONN-100	DigitalMedia 8G Cable Connectors
DM-8G-CRIMP	Crimping Tool for DM-8G-CONN
DM-CBL-8G	DigitalMedia 8G Cable
DM-RMC-100-C	DigitalMedia 8G+ Receiver & Room Controller 100
DM-RMC-200-C	DigitalMedia 8G+ Receiver & Room Controller 200
DM-RMC-SCALER-C	DigitalMedia 8G+ Receiver & Room Controller with Scaler
DM-TX-200-C-2G	Wall Plate DigitalMedia 8G+ Transmitter 200
DM-TX-201-C	DigitalMedia 8G+ Transmitter 201
DM-TX-401-C	DigitalMedia 8G+ Transmitter 401
HD-SCALER	High-Definition Video Scaler
IRP2	IR Emitter Probe
MP-WP Series	Media Presentation Wall Plates
MPI-WP Series	Media Presentation Wall Plates – International Version
PW-4818DU	48V Power Pack for PoDM

- Item(s) sold separately.
- The RGB inputs can accept component, composite, and S-video signals via direct interface to Crestron MPS Series products, or through an appropriate adapter (not included). Input sync detection is not provided for composite or S-video signal types through the RGB connection.
- Deep Color and 3D video signals are only supported via HDMI inputs 1 and 2, and DM inputs 6 and 7.
- HDMI requires an appropriate adapter or interface cable to accommodate a DVI or DisplayPort Multimode signal. CBL-HD-DVI interface cables available separately.
- When a digital audio input (HDMI, DM, or S/PDIF) is routed to an HDMI or DM output, that output is put in “pass-through” mode so that the digital input is the only signal that passes to that output and the audio controls on that output have no effect.

Physical Description

This section provides information on the connections, controls and indicators available on the DMPS-100/200/300-C.

DMPS-300-C Physical View



DMPS-100/200/300-C Overall Dimensions (Side View)

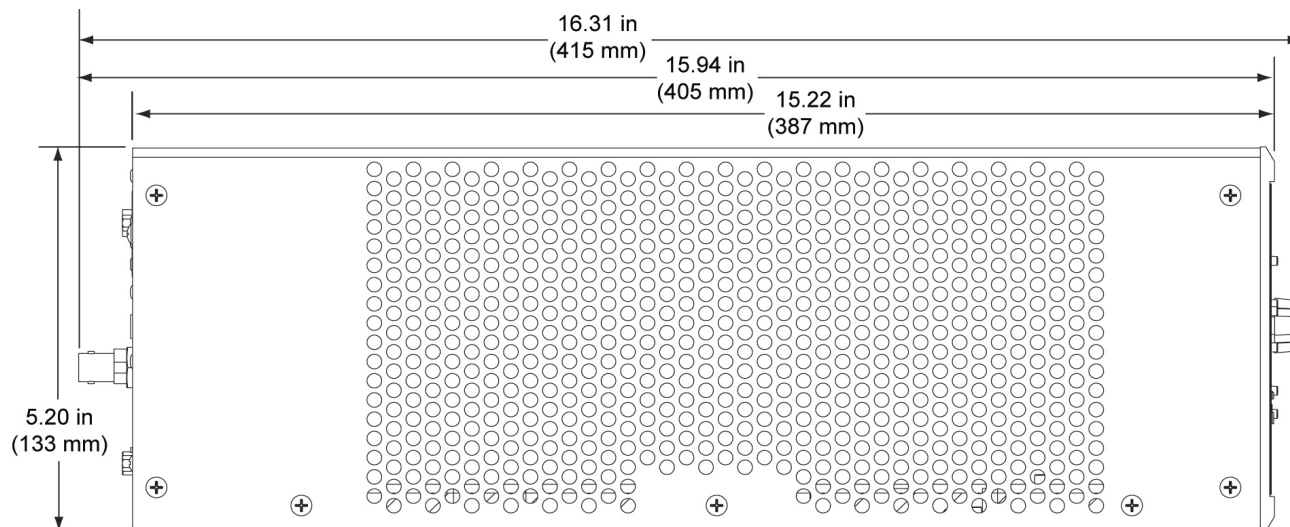

DMPS-100-C Dimensions (Front View)

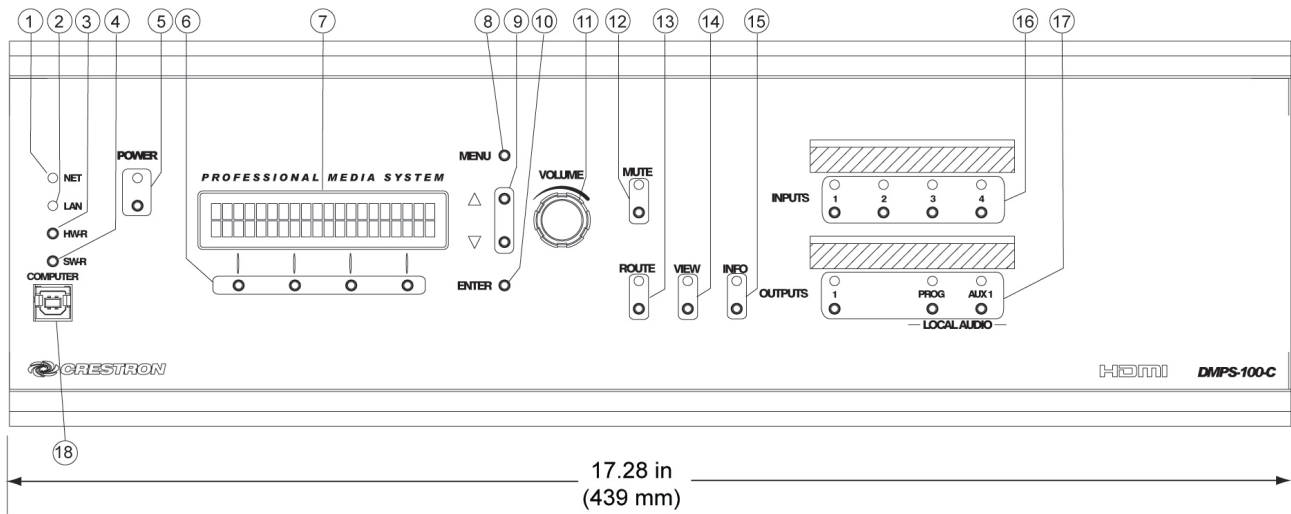

DMPS-100-C (Rear View)

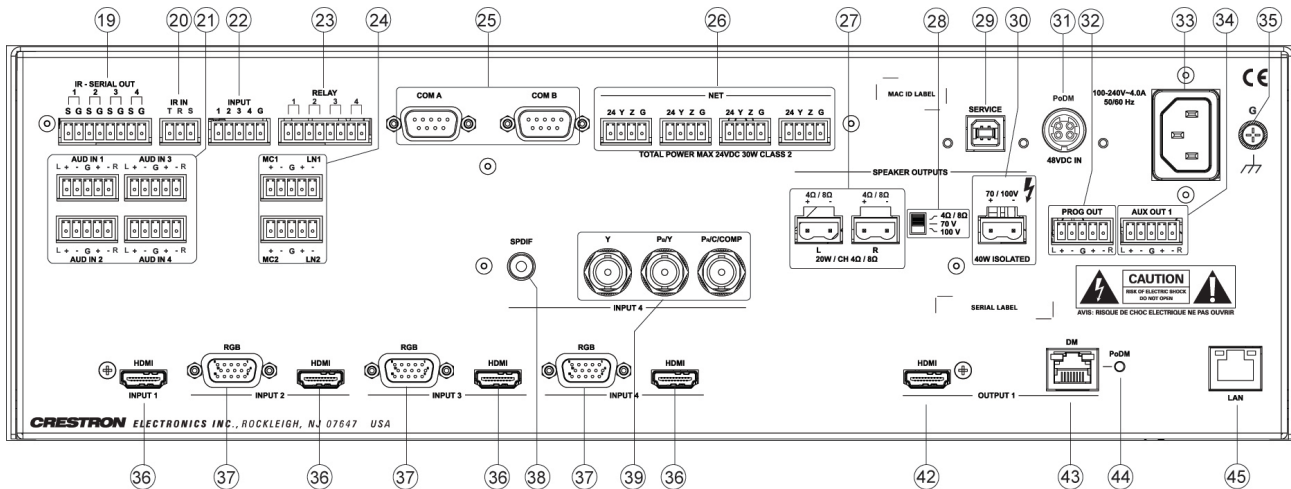

DMPS-200-C Dimensions (Front View)

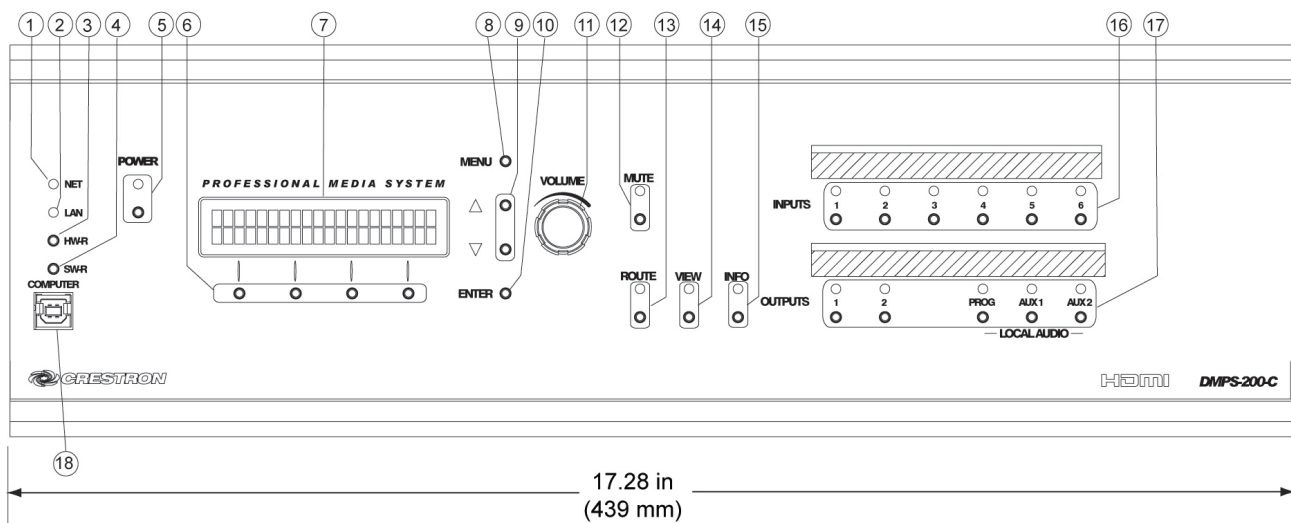

DMPS-200-C (Rear View)

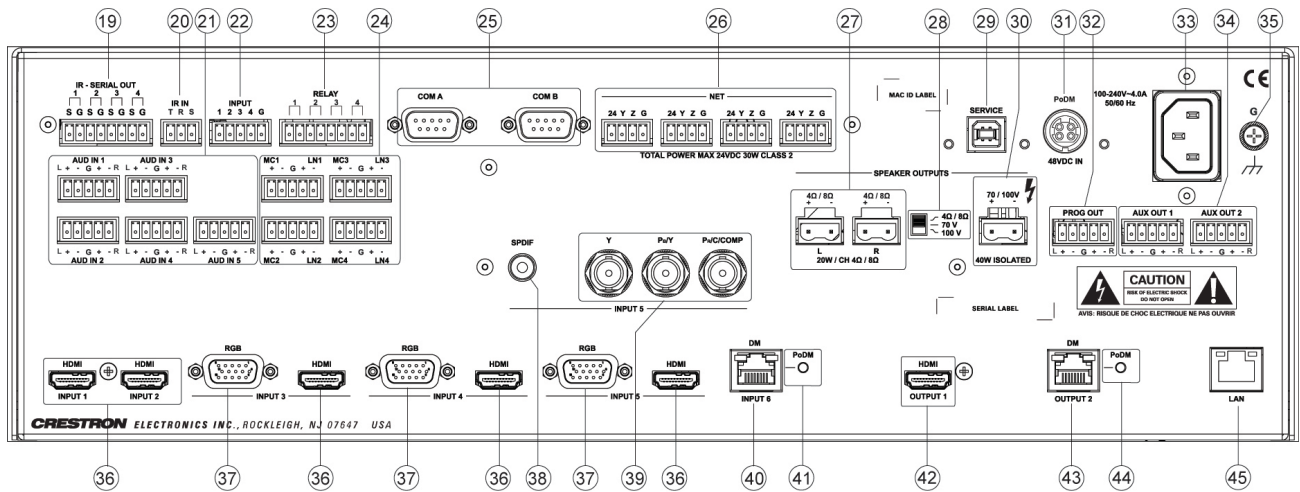

DMPS-300-C Dimensions (Front View)

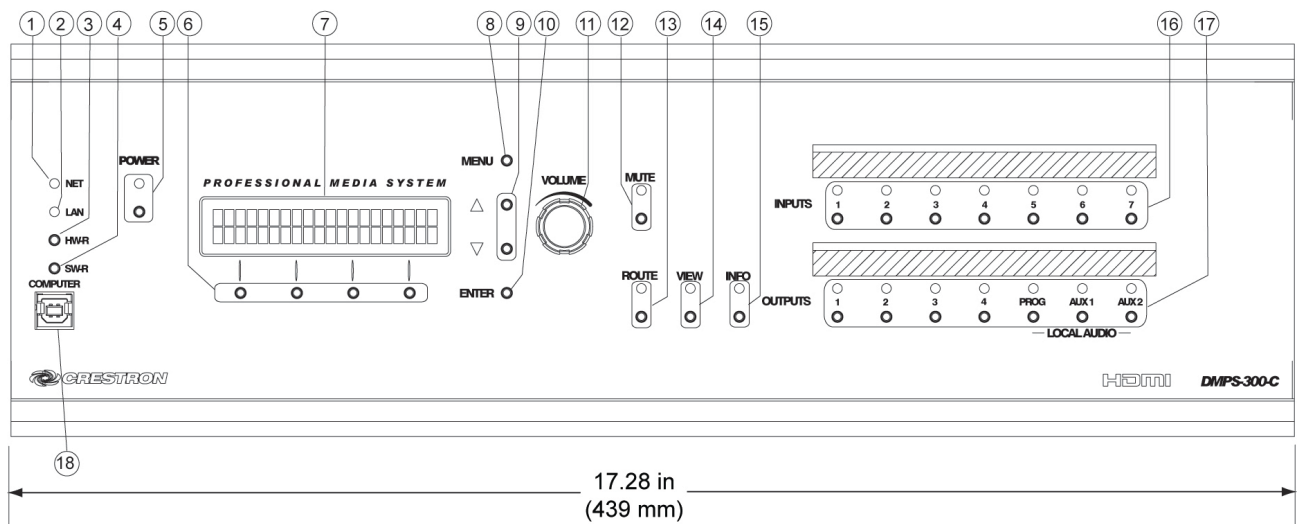

DMPS-300-C (Rear View)

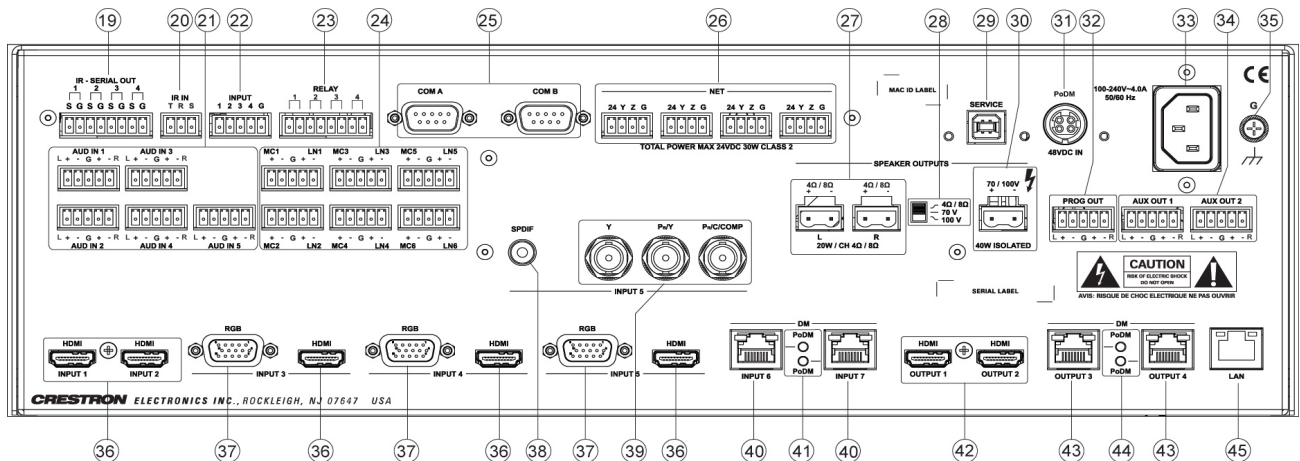

NOTE: In the following table, the reference designation and quantity of several of the connectors and indicators vary between the DMPS-100/200/300-C models. Refer to the previous illustrations and the description in the table for clarification.

Connectors, Controls & Indicators

#	CONNECTORS ¹ , CONTROLS & INDICATORS	DESCRIPTION
1	NET LED	(1) Yellow LED, indicates Cresnet bus activity
2	LAN LED	(1) Yellow LED, indicates Ethernet activity
3	HW-R	(1) Recessed miniature push button for hardware reset, reboots the control system
4	SW-R	(1) Recessed miniature push button for software reset, restarts the SIMPL program
5	POWER	(1) Push button and green LED, programmable for system power control
6	Softkeys	(4) Push buttons for activation of LCD driven functions and passcode entry
7	LCD	Green LCD alphanumeric, adjustable backlight; 2 lines x 20 characters per line; Displays input/outputs by name, volume levels, setup menus, signal routing, device info, and other system information
8	MENU	(1) Push button, provides access to the entire menu structure, and during configuration process, steps menu back one level
9	▲, ▼	(2) Push buttons, scroll up or down through menu and adjust menu parameters
10	ENTER	(1) Push button, executes highlighted menu or value
11	VOLUME 	(1) Continuous turn rotary encoder, adjusts menu parameters, defaults to program audio volume
12	MUTE	(1) Push button and red LED, mutes the program audio output
13	ROUTE	(1) Push button and red LED, selects <i>Route</i> mode to allow routing changes
14	VIEW	(1) Push button and red LED, selects <i>View</i> mode to view current routing
15	INFO	(1) Push button and red LED, selects <i>Info</i> mode to view AV and device info
16	INPUTS	(4) Push buttons and red LEDs, select input to be routed, for DMPS-100-C (6) Push buttons and red LEDs, select input to be routed, for DMPS-200-C (7) Push buttons and red LEDs, select input to be routed, for DMPS-300-C

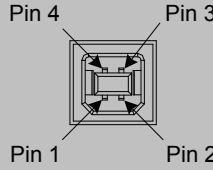
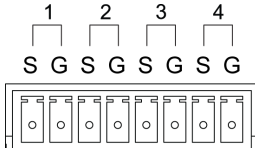
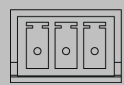
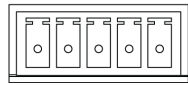
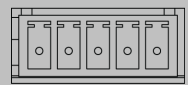

(Continued on following page)

Connectors, Controls & Indicators (Continued)

#	CONNECTORS ¹ , CONTROLS & INDICATORS	DESCRIPTION										
17	OUTPUTS	(3) Push buttons and red LEDs, select outputs 1, PROG, AUX 1 destination(s), for DMPS-100-C (5) Push buttons and red LEDs, select outputs 1 – 2, PROG, AUX 1 - 2 destination(s), for DMPS-200-C (7) Push buttons and red LEDs, select outputs 1 – 4, PROG, AUX 1 - 2 destination(s), for DMPS-300-C										
18	COMPUTER 	(1) USB Type B female USB computer console port (cable included) <table border="1" data-bbox="933 682 1258 861"> <thead> <tr> <th>PIN</th> <th>DESCRIPTION</th> </tr> </thead> <tbody> <tr> <td>1</td> <td>+5 Vdc</td> </tr> <tr> <td>2</td> <td>Data -</td> </tr> <tr> <td>3</td> <td>Data +</td> </tr> <tr> <td>4</td> <td>Ground</td> </tr> </tbody> </table>	PIN	DESCRIPTION	1	+5 Vdc	2	Data -	3	Data +	4	Ground
PIN	DESCRIPTION											
1	+5 Vdc											
2	Data -											
3	Data +											
4	Ground											
19	IR – SERIAL OUT 	(4) 2-pin 3.5 mm detachable terminal blocks, IR/Serial output ports; IR output up to 1.2 MHz; 1-way serial TTL/RS-232 (0-5 volts) up to 9600 baud										
20	IR IN 	(1) 3-pin 3.5 mm detachable terminal block; For connection of the CNXRMRD IR Receiver ² ; Allows control from IR wireless remotes using RC-5 command set										
21	AUD IN 	(4) for DMPS-100-C; (5) for DMPS-200-C and DMPS-300-C; 5-pin 3.5 mm detachable terminal blocks; Balanced/unbalanced stereo line-level analog audio inputs; Input impedance: 24k Ω balanced/unbalanced; Maximum input level: 4 Vrms balanced, 2 Vrms unbalanced NOTE: Analog audio inputs 1-5, S/PDIF input 5, and HDMI inputs 1-5 are mutually exclusive; HDMI and S/PDIF override analog audio when using the auto-switching feature										
22	INPUT 	(1) 5-pin 3.5 mm detachable terminal block; Comprises (4) programmable digital inputs; Input voltage range: 0 to 24 volts dc, referenced to GND; Logic threshold: 2.5 volts dc nominal with 1 volt hysteresis band; Input impedance: 10k Ω @ >5 volts, 1M Ω @ <5 volts; Pull-up resistor: 2.2k Ω per input										



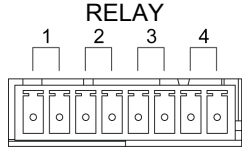
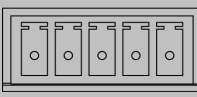
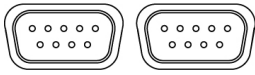



(Continued on following page)

Connectors, Controls & Indicators (Continued)

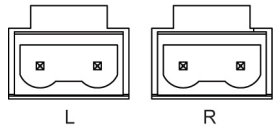
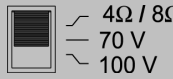
#	CONNECTORS ¹ , CONTROLS & INDICATORS	DESCRIPTION																														
23	<p>RELAY</p> 	<p>(1) 8-pin 3.5 mm detachable terminal block; Comprises (4) normally open, isolated relays; Rated 1 amp, 30 volts ac/dc; MOV arc suppression across contacts</p>																														
24	<p>MC1 LN1 + - G + -</p> 	<p>(2) for DMPS-100-C; (4) for DMPS-200-C; (6) for DMPS-300-C: 5-pin 3.5 mm detachable terminal blocks, comprise balanced microphone/line audio inputs; Balanced mic input level: -57 to -12 dBV, 240 mVrms maximum; Balanced line input level: -28 to +11 dBV, 3.7 Vrms maximum; Unbalanced line input level: -34 to +5 dBV, 1.85 Vrms maximum; Mic input impedance: 3.9k Ω, accepts 60 to 600 Ω source; Line input impedance: 19k Ω balanced, 9.5k Ω unbalanced; Phantom power: 48 volts dc, software enabled/disabled per channel</p>																														
25	<p>COM A – B</p> <p>COM A COM B</p> 	<p>(2) DB9 male, bidirectional RS-232 ports; Up to 115.2k baud, hardware and software handshaking support for communication with serial devices. Can also be used for modem communications. The following table lists the pin assignments of the serial ports.</p> <table border="1"> <thead> <tr> <th>PIN</th> <th>DIRECTION</th> <th>DESCRIPTION</th> </tr> </thead> <tbody> <tr> <td>1</td> <td>To DMPS-100/200/300-C</td> <td>(DCD) Data Carrier Detect</td> </tr> <tr> <td>2</td> <td>To DMPS-100/200/300-C</td> <td>(RXD) Receive Data</td> </tr> <tr> <td>3</td> <td>From DMPS-100/200/300-C</td> <td>(TXD) Transmit Data</td> </tr> <tr> <td>4</td> <td>From DMPS-100/200/300-C</td> <td>(DTR) Data Terminal Ready</td> </tr> <tr> <td>5</td> <td>Common</td> <td>(GND) Ground</td> </tr> <tr> <td>6</td> <td>To DMPS-100/200/300-C</td> <td>(DSR) Data Set Ready</td> </tr> <tr> <td>7</td> <td>From DMPS-100/200/300-C</td> <td>(RTS) Request To Send</td> </tr> <tr> <td>8</td> <td>To DMPS-100/200/300-C</td> <td>(CTS) Clear To Send</td> </tr> <tr> <td>9</td> <td>To DMPS-100/200/300-C</td> <td>(RI) Ring Indicator</td> </tr> </tbody> </table>	PIN	DIRECTION	DESCRIPTION	1	To DMPS-100/200/300-C	(DCD) Data Carrier Detect	2	To DMPS-100/200/300-C	(RXD) Receive Data	3	From DMPS-100/200/300-C	(TXD) Transmit Data	4	From DMPS-100/200/300-C	(DTR) Data Terminal Ready	5	Common	(GND) Ground	6	To DMPS-100/200/300-C	(DSR) Data Set Ready	7	From DMPS-100/200/300-C	(RTS) Request To Send	8	To DMPS-100/200/300-C	(CTS) Clear To Send	9	To DMPS-100/200/300-C	(RI) Ring Indicator
PIN	DIRECTION	DESCRIPTION																														
1	To DMPS-100/200/300-C	(DCD) Data Carrier Detect																														
2	To DMPS-100/200/300-C	(RXD) Receive Data																														
3	From DMPS-100/200/300-C	(TXD) Transmit Data																														
4	From DMPS-100/200/300-C	(DTR) Data Terminal Ready																														
5	Common	(GND) Ground																														
6	To DMPS-100/200/300-C	(DSR) Data Set Ready																														
7	From DMPS-100/200/300-C	(RTS) Request To Send																														
8	To DMPS-100/200/300-C	(CTS) Clear To Send																														
9	To DMPS-100/200/300-C	(RI) Ring Indicator																														
26	<p>NET</p> <p>24 Y Z G</p> 	<p>(4) 4-pin 3.5 mm detachable terminal blocks; Cresnet Master ports, paralleled; Available Cresnet Power: 30 watts 24: Power (24 volts dc) Y: Data Z: Data G: Ground</p>																														

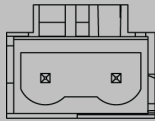

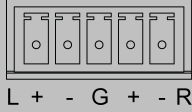

(Continued on following page)

Connectors, Controls & Indicators (Continued)

#	CONNECTORS ¹ , CONTROLS & INDICATORS	DESCRIPTION
27	<p>SPEAKER OUTPUT</p> <p>4Ω / 8Ω 4Ω / 8Ω</p> <p>+ - + -</p>  <p>L R</p>	<p>(2) 2-pin 7.62 mm 15A detachable terminal blocks;</p> <p>4-8 Ω stereo speaker-level audio output;</p> <p>Wire size: Terminals accept up to 14 AWG</p> <p>Output power: 20W RMS per channel stereo at 8 Ω, 4 Ω tolerant;</p> <p>Driven by program audio output</p> <p>NOTE: 4 Ω/8 Ω and 70/100V outputs are mutually exclusive.</p>
28	<p>SPEAKER OUTPUT</p>  <p>4Ω / 8Ω</p> <p>70 V</p> <p>100 V</p>	<p>(1) 3-position slide switch, selects the amplifier output configuration</p>
29	<p>SERVICE</p> 	<p>(1) USB Type B female, for factory use only</p>
30	<p>SPEAKER OUTPUT</p> <p>70 / 100V</p> <p>+ -</p> 	<p>(1) 2-pin 7.62 mm 15A detachable terminal block;</p> <p>Transformer-isolated 70 or 100 volt mono speaker-level audio output;</p> <p>Wire size: Terminals accept up to 14 AWG;</p> <p>Output power: 40 W RMS mono at 70 or 100 volts;</p> <p>Driven by program audio output</p> <p>NOTE: 4 Ω/8 Ω and 70/100V outputs are mutually exclusive.</p>
31	<p>PoDM</p> 	<p>(1) 4-pin snap & lock power jack;</p> <p>48 volt power input for PoDM power pack, sold separately;</p> <p>Enables Power over DM</p>
32	<p>PROG OUT</p>  <p>L + - G + - R</p>	<p>(1) 5-pin 3.5 mm detachable terminal block;</p> <p>Balanced/unbalanced stereo line-level audio output;</p> <p>Output impedance: 200 Ω balanced, 100 Ω unbalanced;</p> <p>Maximum output level: 4 Vrms balanced, 2 Vrms unbalanced</p>
33	<p>100-240V – 4.0A</p> <p>50/60 Hz</p> 	<p>(1) IEC C14 male chassis plug, main power input;</p> <p>Mates with removable power cord, included</p>

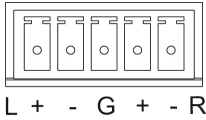
(Continued on following page)

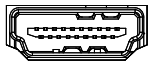
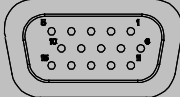
Connectors, Controls & Indicators (Continued)

#	CONNECTORS ¹ , CONTROLS & INDICATORS	DESCRIPTION
34	AUX OUT  L + - G + - R	(1) for DMPS-100; (2) for DMPS-200 and DMPS-300: 5-pin 3.5 mm detachable terminal blocks; Balanced/unbalanced stereo line-level audio outputs; Output impedance: 200 Ω balanced, 100 Ω unbalanced; Maximum output level: 4 Vrms balanced, 2 Vrms unbalanced
35		(1) 6-32 screw, chassis ground lug
36	HDMI INPUT 	(4) for DMPS-100; (5) for DMPS-200 and DMPS-300: 19-pin Type A HDMI female, digital video/audio inputs; Signal types: HDMI, DVI, or DisplayPort Multimode ^{3,4}
37	RGB INPUT 	(3) DB15HD female, analog RGB/video inputs; Signal Types: RGBHV, component, S-video, or composite ^{5,6} Formats: RGBHV, RGBS, RGSB, YPbPr, Y/C, NTSC or PAL; Input level: 0.5 to 1.5 Vp-p with built-in dc restoration; Input impedance: 75 Ω nominal; Sync detection: RGBHV, RGBS, RGSB, YPbPr; Sync input level: 3 to 5 Vp-p; Sync input impedance: 2.2k Ω ; NOTE: RGB inputs 3-5 and HDMI inputs 3-5 are mutually exclusive; HDMI overrides RGB when using the auto-switching feature
38	S/PDIF 	Part of INPUT 4 for DMPS-100; part of INPUT5 for DMPS-200 and DMPS-300: (1) RCA female, S/PDIF coaxial digital audio input; Input impedance: 75 Ω ; NOTE: The respective S/PDIF inputs and HDMI inputs are mutually exclusive; HDMI overrides S/PDIF when using the auto-switching feature. Supported format is 2-channel PCM
39	Y, P _B /Y, P _R /C/COMP 	Part of INPUT 4 for DMPS-100; part of INPUT 5 for DMPS-200 and DMPS-300: (3) BNC female comprising (1) auto-sensing multi-format analog video input; Signal types: Component, S-video, or composite; Formats: YPbPr, Y/C, NTSC or PAL; Input level: 1 Vp-p nominal; Input impedance: 75 Ω nominal; NOTE: The respective video inputs, RGB inputs, and HDMI inputs are mutually exclusive; HDMI and RGB override video when using the auto-switching feature

(Continued on following page)

Connectors, Controls & Indicators (Continued)

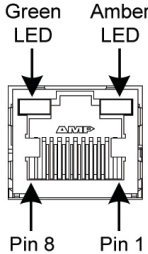
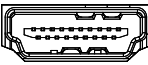
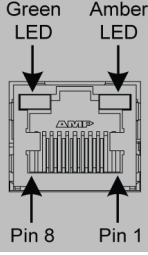
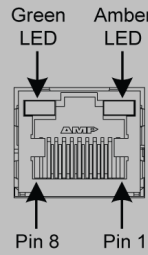
#	CONNECTORS ¹ , CONTROLS & INDICATORS	DESCRIPTION																				
40	<p>DM INPUT</p> 	<p>Not present on DPMS-100, (1) for DMPS-200, (2) for DMPS-300: 8-pin RJ-45 female, shielded; DM 8G+ inputs, capable of supplying power over DM⁷;</p> <p>Connects to DM 8G+ output of a DM transmitter or other DM device via CAT5e or Crestron DM-CBL-8G cable⁸</p> <p>(2) LEDs, green LEDs indicate DM link status; Amber LEDs indicate video and HDCP signal presence, for each respective port</p>																				
41	<p>DM INPUT PoDM LEDs</p>	<p>Not present on DPMS-100, (1) for DMPS-200, (2) for DMPS-300: Green LEDs, indicate upstream device is drawing power over DM for each respective port</p>																				
42	<p>HDMI OUTPUT</p> 	<p>(1) for DMPS-100 and DMPS-200, (2) for DMPS-300: 19-pin Type A HDMI female, digital video/audio outputs; Signal types: HDMI, DVI³</p>																				
43	<p>DM OUTPUT</p> 	<p>(1) for DMPS-100 and DMPS-200, (2) for DMPS-300: 8-pin RJ-45 female, shielded; DM 8G+ outputs, capable of supplying power over DM⁷;</p> <p>Connects to DM 8G+ input of a DM receiver/room controller or other DM device via CAT5e or Crestron DM-CBL-8G cable⁸</p> <p>(2) LEDs, green LEDs indicate DM link status, amber LEDs indicate video and HDCP signal presence, for each respective port</p>																				
44	<p>DM OUTPUT PoDM LEDs</p>	<p>(1) for DMPS-100 and DMPS-200, (2) for DMPS-300: Green LEDs, indicate downstream device is drawing power over DM for each respective port</p>																				
45	<p>LAN</p> 	<p>(1) 8-wire RJ-45 female; 10BASE-T/100BASE-TX/1000BASE-T Ethernet port; Right LED: green LED indicates Ethernet link status</p> <p>Left LED: bi-color LED; amber blink indicates 1000 Mbps activity, green and amber blink mix indicates 100 Mbps activity, and green blink indicates 10 Mbps activity</p> <table border="1" data-bbox="933 1596 1396 1753"> <thead> <tr> <th>PIN</th> <th>SIGNAL</th> <th>PIN</th> <th>SIGNAL</th> </tr> </thead> <tbody> <tr> <td>1</td> <td>BI_DA+</td> <td>5</td> <td>BI_DC-</td> </tr> <tr> <td>2</td> <td>BI_DA-</td> <td>6</td> <td>BI_DB-</td> </tr> <tr> <td>3</td> <td>BI_DB+</td> <td>7</td> <td>BI_DD+</td> </tr> <tr> <td>4</td> <td>BI_DC+</td> <td>8</td> <td>BI_DD-</td> </tr> </tbody> </table>	PIN	SIGNAL	PIN	SIGNAL	1	BI_DA+	5	BI_DC-	2	BI_DA-	6	BI_DB-	3	BI_DB+	7	BI_DD+	4	BI_DC+	8	BI_DD-
PIN	SIGNAL	PIN	SIGNAL																			
1	BI_DA+	5	BI_DC-																			
2	BI_DA-	6	BI_DB-																			
3	BI_DB+	7	BI_DD+																			
4	BI_DC+	8	BI_DD-																			

- Interface connectors for **IR-SERIAL OUT, IR IN, AUD IN, INPUT, RELAY, MC-LN, NET, SPEAKER OUTPUTS, PROG OUT,** and **AUX OUT** ports are provided with the device.
- Item(s) sold separately.
- HDMI requires an appropriate adapter or interface cable to accommodate a DVI or DisplayPort Multimode signal. CBL-HD-DVI interface cables available separately.
- Deep Color and 3D video signals are only supported via HDMI inputs 1 and 2, and DM inputs 6 and 7.

5. The RGB inputs can accept component, composite, and S-video signals via direct interface to Crestron MPS Series products, or through an appropriate adapter (not included). Input sync detection is not provided for composite or S-video signal types through the RGB connection.
6. Refer to the following table for the **RGB IN** connector pinouts.

PIN #	RGB	YPbPr	S-VIDEO	COMPOSITE
1	R	Pr	C	
2	G	Y	Y	
3	B	Pb		Comp
13	H			
14	V			

7. Supplying Power over DM (PoDM) requires external power pack, sold separately.
8. For DM 8G+ wiring up to 330 ft (100 m) between devices, use Crestron DM-CBL-8G DigitalMedia 8G cable, Crestron DM-CBL DigitalMedia cable, Crestron DM-CBL-D DigitalMedia D cable, or generic CAT5e (or better) UTP or STP. Shielded cable and connectors are recommended to safeguard against unpredictable environmental electrical noise which may impact performance at resolutions above 1080p. Refer to the Crestron DigitalMedia Design Guide (Doc. 4546) for complete system design guidelines. All cable sold separately.

Setup

Network Wiring

When wiring the network, consider the following:

- Use Crestron Certified Wire.
- Use Crestron power supplies for Crestron equipment.
- Provide sufficient power to the system.
- For DigitalMedia CAT wiring, use DM-CBL DigitalMedia cable. Up to two DM Repeaters (model DM-DR, sold separately) may be required. Refer to the latest version of the Crestron DigitalMedia Design Guide (Doc. 4546) for complete wiring guidelines. It is available from the Crestron Web site (www.crestron.com/manuals).
- For DigitalMedia 8G™ STP wiring, use DM-CBL-8G or DM-CBL-D cable. Using DM-CBL-8G, the maximum cable length is 330 feet (100 meters). Using DM-CBL-D cable, the maximum cable length is 200 feet (61 meters).

CAUTION: Insufficient power can lead to unpredictable results or damage to the equipment. Use the Crestron Power Calculator to help calculate how much power is needed for the system (www.crestron.com/calculators).

NOTE: For optimum performance and ESD (electrostatic discharge) protection, Crestron strongly recommends using DM-CBL-8G cable.

For Cresnet® networks with 20 or more devices, use a Cresnet Hub/Repeater (CNXHUB) to maintain signal quality.

For more details, refer to “Check Network Wiring” which starts on page 66.

For general information on connecting Ethernet devices in a Crestron system, refer to the latest version of the Crestron e-Control® Reference Guide (Doc. 6052).

For information specifically related to Ethernet connectivity using DigitalMedia devices, refer to the latest version of the Crestron IP Considerations Guide for the IT Professional (Doc. 4579).

CAT5 Wiring

Category 5 (CAT5) wiring is a twisted pair cable designed for Ethernet networks. These networks operate at speeds of up to 100 megabits per second (Mbps) using the 100BASE-T standard. Crestron takes advantage of this specification for a variety of audio and video applications.

When using a Crestron wiring solution, CAT5e or DM 8G cable can carry audio and video signals up to 330 feet (100 meters) (observe distance limitations based upon power consumption for the device in use).

For more information, refer to the latest version of the Crestron CAT5 Wiring Reference Guide (Doc. 6137).

Installation

Ventilation

The DMPS-100/200/300-C should be used in a well-ventilated area. The venting holes should not be obstructed under any circumstances.

To prevent overheating, do not operate this product in an area that exceeds the environmental temperature range listed in the table of specifications. Consider using forced air ventilation to reduce overheating. Contact with thermal insulating materials should be avoided on all sides of the unit.

Rack Mounting

The DMPS-100/200/300-C can be mounted in a rack or stacked with other equipment. Two “ears” are provided with each unit so that it can be rack mounted. These ears must be installed prior to mounting. Complete the following procedure to attach the ears to the unit. The only tool required is a #1 or #2 Phillips screwdriver.

WARNING: To prevent bodily injury when mounting or servicing this unit in a rack, observe the following guidelines.

- When mounting this unit in a partially filled rack, load the rack from the bottom to the top with the heaviest component at the bottom of the rack.
- If the rack is provided with stabilizing devices, install the stabilizers before mounting or servicing the unit in the rack.

NOTE: Observe the following guidelines when installing equipment in a rack:

- Elevated Operating Ambient Temperature - If installed in a closed or multi-unit rack assembly, the operating ambient temperature of the rack environment may be greater than room ambient temperature. Therefore, consideration should be given to installing the equipment in an environment compatible with the maximum ambient temperature (T_{ma}) specified by the manufacturer.
- Reduced Air Flow - Installation of the equipment in a rack should be such that the amount of airflow required for safe operation of the equipment is not compromised.
- Mechanical Loading - Mounting of the equipment in the rack should be such that a hazardous condition is not achieved due to uneven mechanical loading.
- Circuit Overloading - Consideration should be given to the connection of the equipment to the supply circuit and the effect that overloading of the circuits might have on overcurrent protection and supply wiring. Appropriate consideration of equipment nameplate ratings should be used when addressing this concern.
- Reliable Earthing - Reliable earthing of rack-mounted equipment should be maintained. Particular attention should be given to supply connections other than direct connections to the branch circuit (e.g., use of power strips)

NOTE: If rack mounting is not required, rubber feet are provided for tabletop mounting or stacking. Apply the feet near the corner edges on the underside of the unit.

To install the ears use the following procedure:

CAUTION: To prevent equipment damage, use only the rack ears Crestron provides for this device.

1. There are screws that secure each side of a DMPS-100/200/300-C top cover. Using a #1 or #2 Phillips screwdriver, remove the three screws closest to the front panel from one side of the unit. Refer to the diagram following step 3 for a detailed view.
2. Position a rack ear so that its mounting holes align with the holes vacated by the screws in step 1.
3. Secure the ear to the unit with three screws from step 1, as shown in the following diagram.

Ear Attachment for Rack Mounting

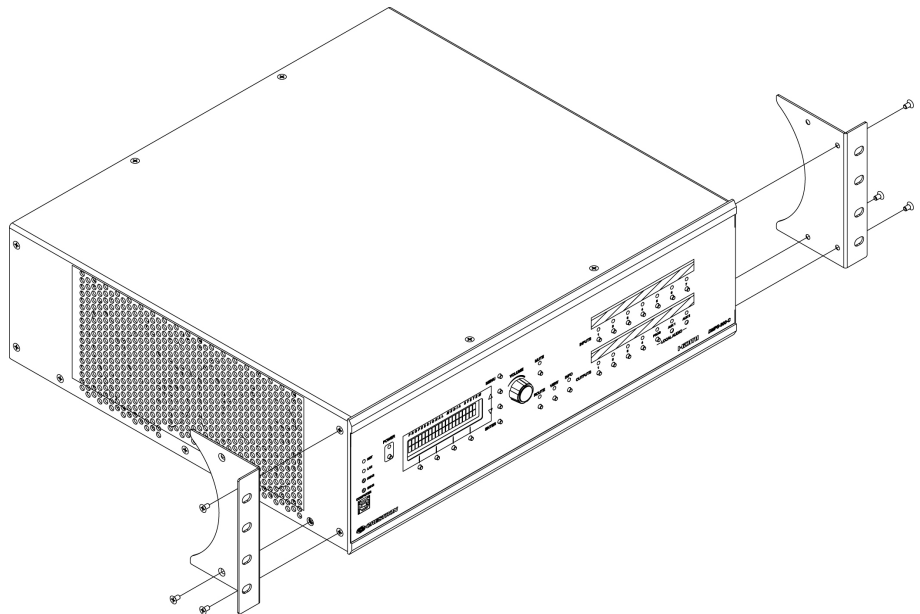

4. Repeat procedure (steps 1 through 3) to attach the remaining ear to the opposite side.

Stacking

Four “feet” are provided with the DMPS-100/200/300-C so that if the unit is not rack mounted, the rubber feet can provide stability when the unit is placed on a flat surface or stacked. These feet should be attached prior to the hookup procedure. Refer to the following illustration for placement of the feet.

Foot Placement for the DMPS-100/200/300-C

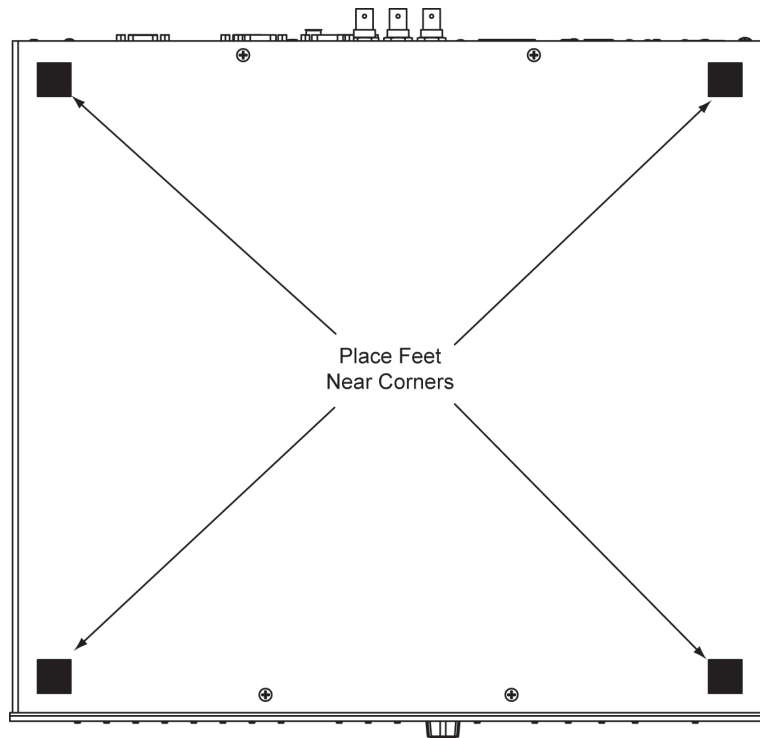

NOTE: No more than two DMPS-100/200/300-C devices should be stacked.

Hardware Hookup

Connect the Device

Make the necessary connections as called out in the illustration that follows this paragraph. Refer to “Network Wiring” on page 29 before attaching the 4-position terminal block (**NET**) connectors. Apply power after all connections have been made.

When making connections to the DMPS-100/200/300-C, use Crestron power supplies for Crestron equipment.

Hardware Connections for the DMPS-100/200/300-C Front Panels (DMPS-300-C Shown)

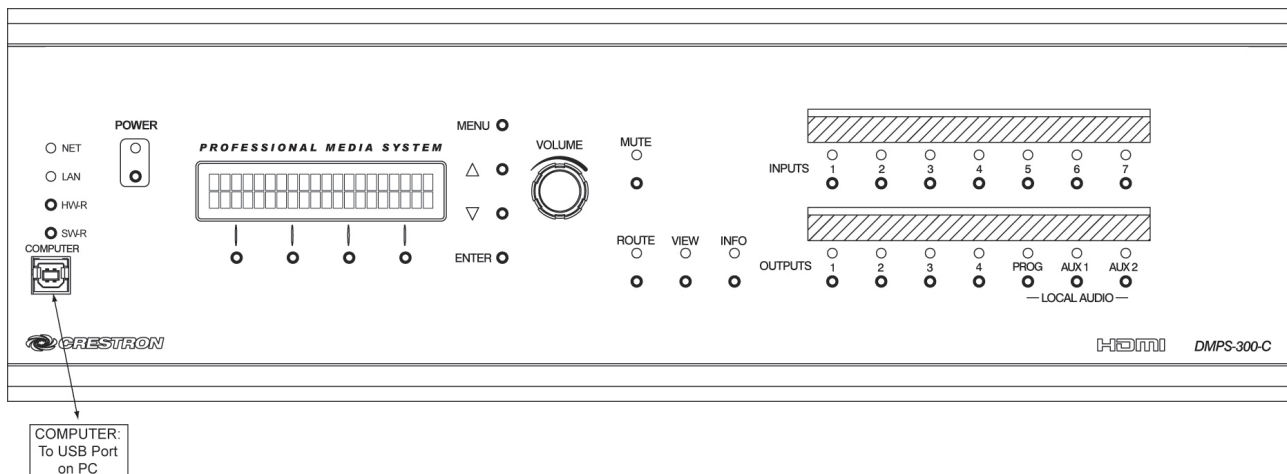

Hardware Connections for the DMPS-100-C

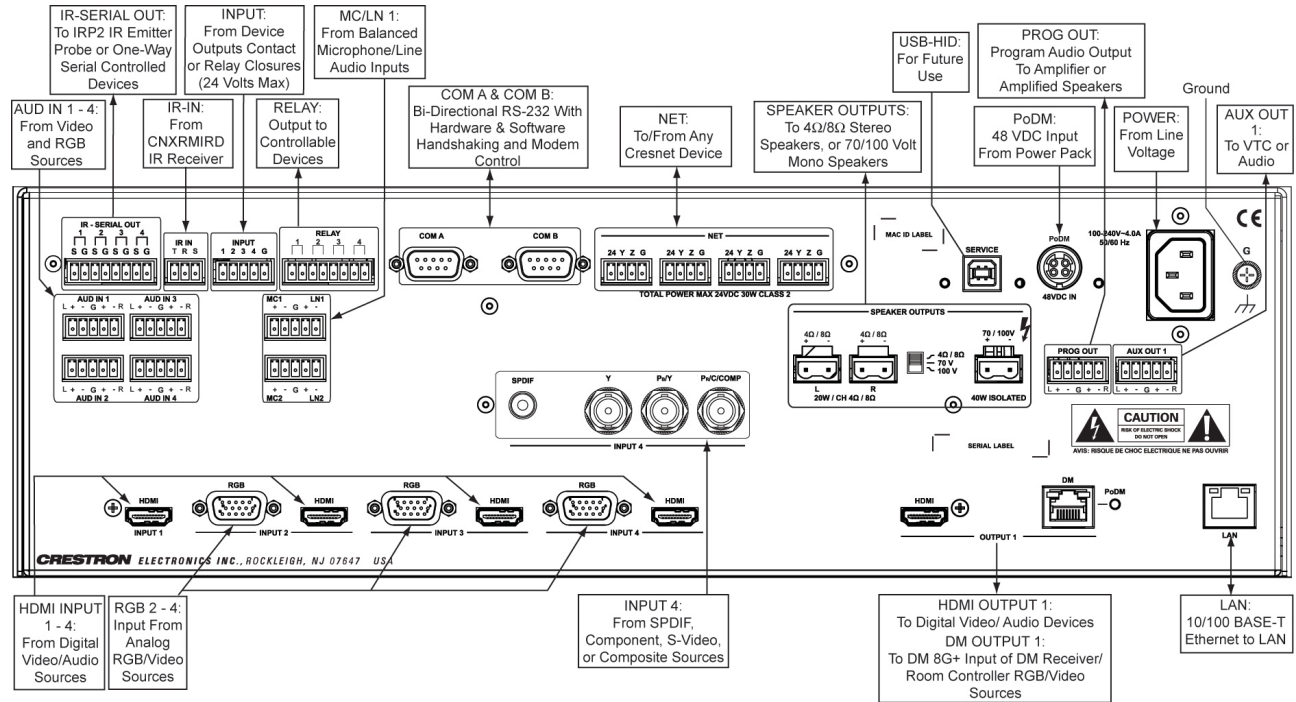

Hardware Connections for the DMPS-200-C

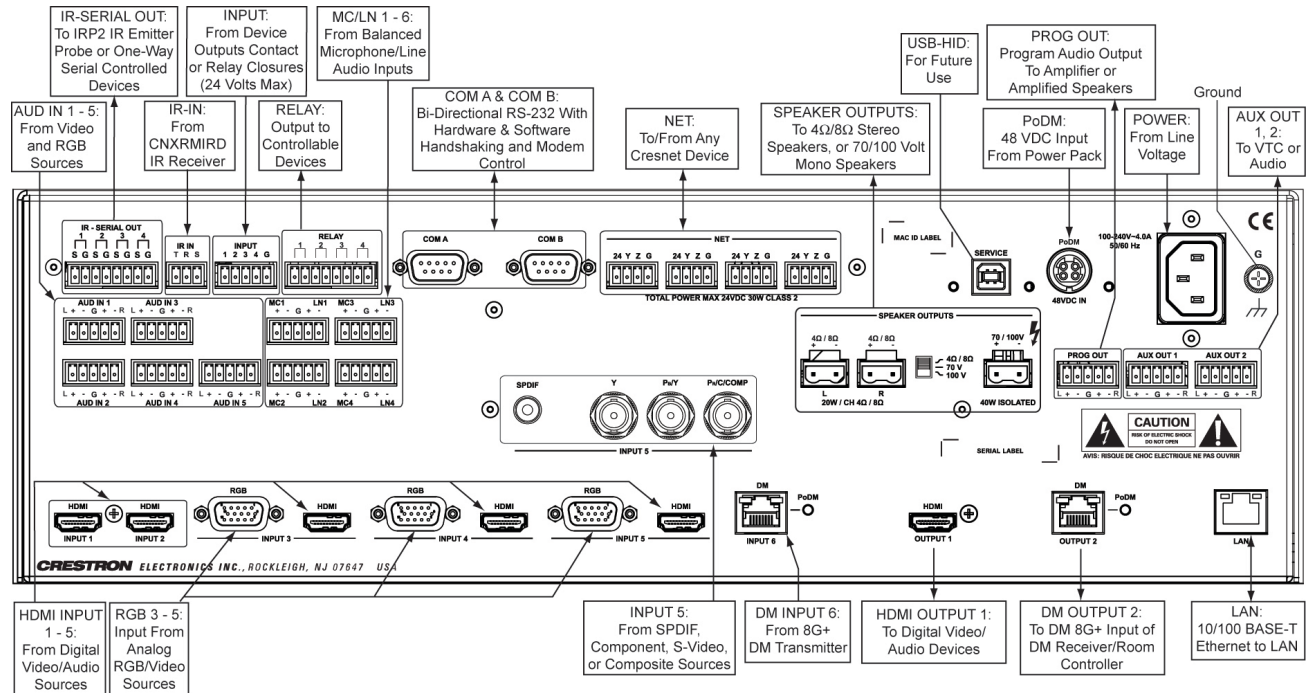

Hardware Connections for the DMPS-300-C/300-C-AEC

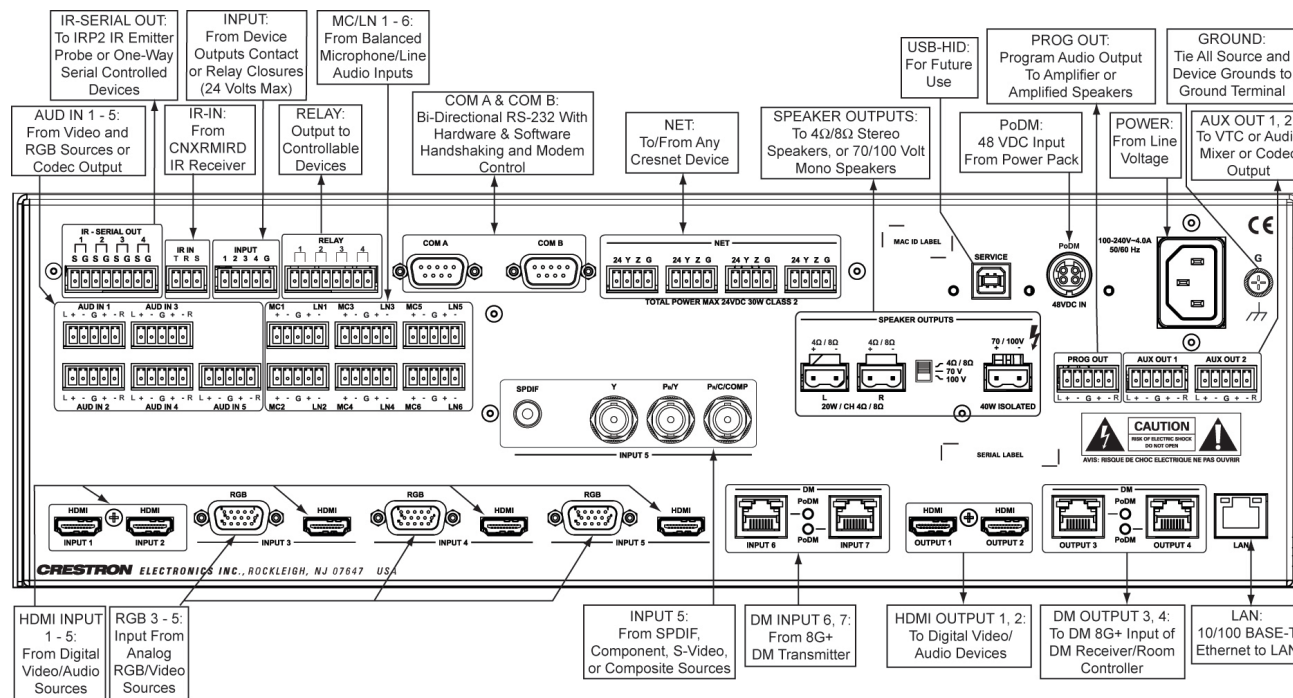

NOTE: Ensure the unit is properly grounded by connecting the chassis ground lug to an earth ground (building steel).

NOTE: To prevent overheating, do not operate this product in an area that exceeds the environmental temperature range listed in the table of specifications.

NOTE: For optimum performance, Crestron requires using DM-CBL DigitalMedia cable, available from Crestron.

NOTE: Minimum allowed length for DM-CBL DigitalMedia cable is 15 feet (~4.6 meters).

Six balanced/unbalanced audio inputs are provided, utilizing five-pin terminal block connectors. For connection details, refer to the following table and diagrams.

Audio Connections

SIGNAL NAME	BALANCED AUDIO INPUT	BALANCED AUDIO OUTPUT	UNBALANCED AUDIO INPUT	UNBALANCED AUDIO OUTPUT
+	L +	L +	L + In	L + Out
-	L -	L -	L – signal return, jumper to GND	Open
G	Shield/ground	Shield/ground	Ground	Common ground
+	R +	R +	R + In	R + Out
-	R -	R -	R – signal return jumper to GND	Open

Typical Balanced/Unbalanced Inputs

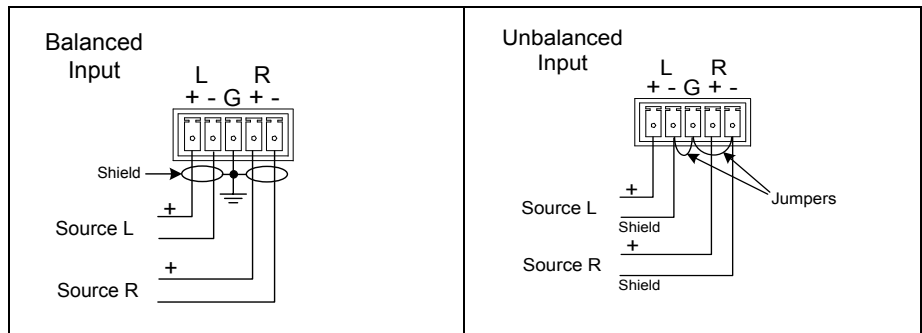

Typical Balanced/Unbalanced Outputs

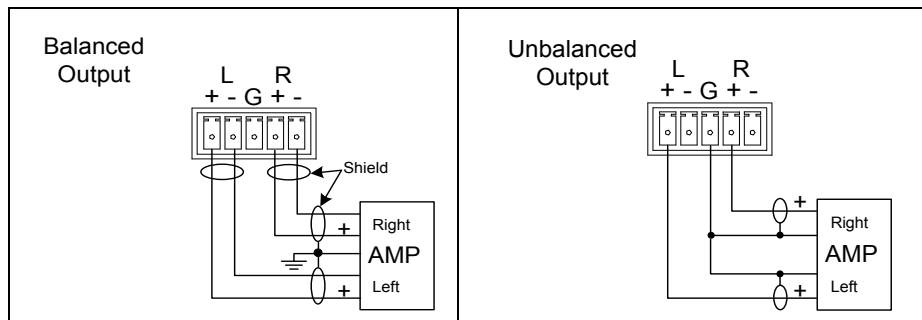

Label the Buttons

Use Creston Engraver software to print custom labels for the DMPS-100/200/300-C front panel input and output buttons and LEDs. Creston recommends printing on 100 pound paper. Paper weighing less than 100 pounds tends to crumple while sliding in, while paper weighing more than 100 pounds may not fit.

Uploading and Upgrading

Crestron recommends using the latest programming software and that each device contains the latest firmware to take advantage of the most recently released features. However, before attempting to upload or upgrade it is necessary to establish communication. Once communication has been established, files (for example, programs or firmware) can be transferred to the control system (or device). Finally, program checks can be performed (such as changing the device ID or creating an IP table) to ensure proper functioning.

NOTE: Crestron software and any files on the Web site are for authorized Crestron dealers and Crestron Service Providers (CSPs) only. New users must register to obtain access to certain areas of the site (including the FTP site).

While the next section provides an overview for communication, refer to “Establishing Communications with the Control System” in the latest version of the Crestron 2-Series Control Systems Reference Guide (Doc. 6256) for connection details. If communications cannot be established, refer to “Troubleshooting Communications” in the same guide.

Establishing Communication

Use Crestron Toolbox for communicating with the DMPS-100/200/300-C; refer to the Crestron Toolbox help file for details. There are two methods of communication: USB and TCP/IP.

USB

NOTE: Required for initial setup of Ethernet parameters.

NOTE: Required for loading projects and firmware

USB Communication

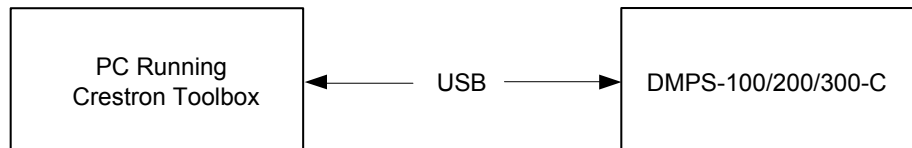

The **COMPUTER** port on the DMPS-100/200/300-C connects to the USB port on the PC via the included Type A to Type B USB cable.

1. Use the Address Book in Crestron Toolbox to create an entry using the expected communication protocol (USB). When multiple USB devices are connected, identify the DMPS-100/200/300-C by entering “DMPS-300-C”, “DMPS-200-C”, or “DMPS-100-C” in the *Model* text box, the unit’s serial number in the *Serial* text box or the unit’s hostname in the *Hostname* text box. The hostname can be found in the “System Info” dialog box in the section marked *Ethernet* however, communications must be established in order to see this information in the “System Info” dialog box.
2. Display the DMPS-100/200/300-C’s “System Info” dialog box (click the  icon); communications are confirmed when the device information is displayed.

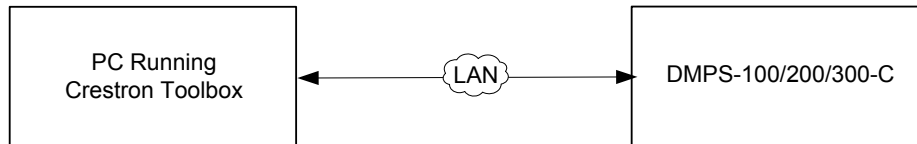
TCP/IP**Ethernet Communication**

The DMPS-100/200/300-C connects to PC via Ethernet:

1. Establish communication between DMPS-100/200/300-C and PC.
2. Confirm Ethernet connection between DMPS-100/200/300-C and PC. If connecting through a hub or router, use CAT5 straight through cables with 8-pin RJ-45 connectors. Alternatively, use a CAT5 crossover cable to connect the two **LAN** ports directly without using a hub or router.
3. Use the Device Discovery Tool in Crestron Toolbox to find the IP address of the DMPS-100/200/300-C. The tool is available in Toolbox version 1.15.143 or later.
4. Use the Address Book in Crestron Toolbox to create an entry for the DMPS-100/200/300-C with the DMPS-100/200/300-C's TCP/IP communication parameters.
5. Display the "System Info" window (click the **i** icon) and select the DMPS-100/200/300-C entry from the Address Book or the Address Book drop-down list.
6. Use Crestron Toolbox to create the DMPS-100/200/300-C IP table.
 - a. Select **Functions | IP Table Setup**.
 - b. Add, modify or delete entries in the IP table. The DMPS-100/200/300-C can have only one IP table entry.
 - c. A defined IP table can be saved to a file or sent to the device.
7. When using the DMPS-100/200/300-C as a "slave", edit the "master" control system's IP table to include an entry for the DMPS-100/200/300-C. The entry should list the DMPS-100/200/300-C's IP ID (specified on the DMPS-100/200/300-C's IP table) and its IP address.

Firmware

Firmware files may be distributed from programmers to installers or from Crestron to dealers. Firmware upgrades are available from the Crestron Web site as new features are developed after product releases. One has the option to upload and upgrade via the Crestron Toolbox. For details on uploading and upgrading, refer to the Crestron Toolbox help file.

For details on upgrading, refer to the Crestron Toolbox help file.

Check the Crestron Web site to find the latest firmware. (New users must register to obtain access to certain areas of the site, including the FTP site.)

Upgrade DMPS-100/200/300-C firmware via Crestron Toolbox:

1. Establish communication with the DMPS-100/200/300-C and display the "System Info" window.
2. Select **Functions | Firmware...** to upgrade the DMPS-100/200/300-C firmware.

IP Configuration

In *Static IP Address* mode, devices connected to the DMPS-100/200/300-C receive a static IP configuration equivalent to the DMPS-100/200/300-C IP address plus their slot number. This configuration is sent when the DMPS-100/200/300-C starts up.

1. Turn off DHCP
2. Set the IP Mask
3. Set the default router
4. Set the IP address

Refer to the following table. In this example, the user assigns the DMPS-100/200/300-C a static address (the main address). All other connected device addresses are configured in the following manner.

Static IP Address Configuration of DMPS-100/200/300-C Inputs/Outputs

DMPS-100/200/300-C INPUTS/OUTPUTS	IP ADDRESS
DMPS-100/200/300-C (main address)	192.168.1.100
Audio Board	No IP address
Video Board (main + 1)	192.168.1.101
DMIn 6 = Video board + slot# = (main +2) + 6 = main + 7	192.168.1.107
DMIn 7 = Video board + slot# = (main +1) + 7 = main + 8	192.168.1.108
DMOut 3 = Video board + slot# = (main +1) + 19 = main + 20	192.168.1.120
DMOut 4 = Video board + slot# = (main +1) + 20 = main + 21	192.168.1.121

Private Network mode (PNM) is supported on all DMPS models. When *Private Network* mode is enabled, the main board [control board] takes an IP address and so does the video board. In *Static IP* mode, the user may set the IP address of the main board, and the video board will take that IP address + 1 (just as with PNM disabled). All downstream TX and RMC devices will be hidden behind the IP address of the video board.

DMPS Tool

In the Crestron Toolbox Address Book, select the DMPS-100/200/300-C. Then use the DMPS Tool to configure EDID, HDCP or to troubleshoot AV on the DMPS-100/200/300-C. Refer to the help file for additional information.

DMPS Tool



Configuration & Operation

The DMPS-100/200/300-C can be used for audio and video switching without any programming required. This is ideal for those that need a basic audio-video switching system. Prior to operation, the DMPS-100/200/300-C must be configured for use.

Configuration

The DMPS-100/200/300-C is configured using the built-in “Setup Menu”.

Access the “Setup Menu”

To access the “Setup Menu”:

1. Press the **POWER** button to turn on the system.
2. Press the **MENU** button. Instructions for entering the numeric password are displayed followed by a blinking cursor that prompts entering of the password.

Enter Password

Enter Password: _

NOTE: The default password is **12345**. It can be changed within the “Control Setup” menu. Refer to “Change the Front Panel Password” on page 58 for more information.

3. Turn the **VOLUME** control until the correct digit (0 through 9) appears.
4. Press the ▲ button to move the cursor to the next digit and select the next digit in the password with the **VOLUME** control. Press the ▼ button to move to a previous digit.
5. Press **ENTER** once the entire password is displayed. If an incorrect password is entered, the display shows “Invalid Password” and returns to the “Enter Password:” screen.

Exit the “Setup Menu”

To exit the “Setup Menu”:

1. While in the “Setup Menu”, press the **MENU** button to exit the menu.

Exit Menu Prompt

Exit Setup Menu?
Yes No
● ●

2. Press the button under *Yes* to exit the menu or press the button under *No* to return to the menu.

NOTE: When the system is being configured, system operation is suspended.

“Setup Menu” Structure

The following diagram displays the “Setup Menu” structure of the DMPS-100/200/300-C.

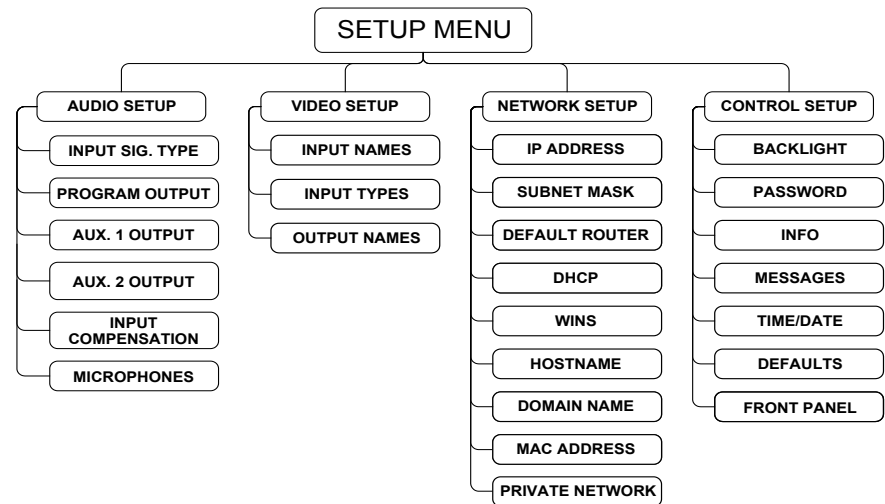
DMPS-100/200/300-C “Setup Menu” Structure

The “Setup Menu” is composed of four sections.

1. *Audio Setup*: Contains controls for input signal types, program output, auxiliary output 1 and 2 settings, source input compensation, and microphones.
2. *Video Setup*: Contains controls for naming input sources, selecting input signal types (video inputs only), and naming output destinations.
3. *Network Setup*: Contains controls for setting the IP address of the DMPS-100/200/300-C, the IP address of the subnet mask used by the DMPS-100/200/300-C, the IP address of the default router used by the DMPS-300-C, the *DHCP* mode and the *WINS* mode of the DMPS-100/200/300-C. The Network Setup section can also display the hostname and MAC address of the DMPS-300-C as well as the domain name used by the DMPS-100/200/300-C.
4. *Control Setup*: Contains controls for adjusting the LCD backlight, setting the front panel password, displaying system information, displaying system messages, setting the time and date, and restoring default settings.

Audio Setup

The audio characteristics of the DMPS-100/200/300-C can be configured from the front panel using the “Audio Setup” menu.

Access the “Audio Setup” Menu

To access the “Audio Setup” menu:

1. Access the “Setup Menu” as described on page 39. The words *Audio Setup* are displayed.

“Setup Menu”

2. Press **ENTER** to display the “Audio Setup” menu.
3. To exit the “Audio Setup” menu, press **MENU**.

Input Signal Type

The *Input Sig. Type* section of the “Audio Setup” menu is used to set the input signal types to the **AUD IN 1** through **AUD IN 5** connectors as *Auto*, *HDMI*, or *Analog*.

NOTE: For inputs 3, 4, and 5, there is no audio output if the audio input type is set to HDMI, and the video input type is set to something other than HDMI.

Access Input Signal Types

To access input signal types:

1. Access the “Audio Setup” menu as described on page 40. The words *Input Sig. Type* are displayed.

“Audio Setup” Menu

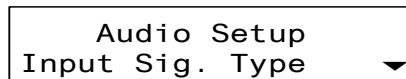

2. Press **ENTER** to display the “Sel. Input Type” menu.
3. To return to the “Audio Setup” menu, press **MENU**.

Set the Signal Type for Each Input

To set the signal types:

1. Access the “Sel. Input Type” menu as described above.

“Sel. Input Type” Menu

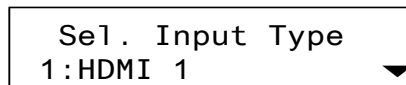

2. Press the ▲ and ▼ buttons to select between *1:HDMI 1*, *2:HDMI 2*, *3:HDMI/VGA 3*, *4:HDMI/VGA 4*, and *5:HDMI/VGA/COMP* signal source types.

NOTE: Input 5 is not present on DMPS-100-C.

3. Press **ENTER** to confirm the selection. The LCD displays the “Select Input 1 Type” menu.

“Select Input 1 Type” Menu

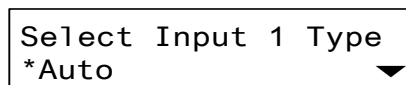

4. For each input type, press the ▲ or ▼ buttons to select between *Auto*, *HDMI*, and *Analog* signal types. The *5:HDMI/VGA/COMP* signal source type menu offers a fourth signal type: *S/PDIF*. Press **ENTER** to confirm the selection.
5. Repeat the above procedures to select the desired input signal type for each input source type.
6. To return to the “Sel. Input Type” menu, press **MENU**.

Program Output

The *Program Output* section of the “Audio Setup” menu is used to set the program output source mix, bass, treble, program delay, minimum volume, maximum volume, startup volume, and stereo/mono settings.

Access the “Program Output” Menu

To access the “Program Output” menu:

1. Access the “Audio Setup” menu as described on page 40.
2. Press the ▲ or ▼ buttons until *Program Output* is displayed on the LCD and press **ENTER** to display the “Program Output” menu.
3. To return to the “Audio Setup” menu, press **MENU**.

Set the Program Source Mix

To set the program source mix:

1. Access the “Program Output” menu as described above.
2. Press the ▲ or ▼ buttons until *Source Mix* is displayed on the LCD and press **ENTER** to display the “Program Source Mix” menu.

“Program Source Mix” Menu

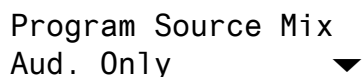

Program Source Mix
Aud. Only ▼

3. Press the ▲ or ▼ buttons until the desired setting is displayed on the LCD. The current setting is indicated with an asterisk (*). The following settings are available:
 - *Aud. Only*: Sends the audio signal from the selected source to the **PROG OUT** connector.
 - *Mic. Only*: sends the microphone input signal to the **PROG OUT** connector.
 - *Mic + Aud*: Sends a mix of the audio signal from the selected source and the microphone input signals to the **PROG OUT** connector.

NOTE: While setting the program source mix, the program volume level can be adjusted by turning the **VOLUME** control clockwise to raise the volume, or counterclockwise to lower the volume. When adjusting the volume, the display changes to indicate the volume level.

4. Press **ENTER** to save changes and return to the previous screen. To cancel without saving changes, press **MENU**.

Set the Program Bass Level

To set the program bass level:

1. Access the “Program Output” menu as described above.
2. Press the ▲ or ▼ buttons until *Bass* is displayed on the LCD and press **ENTER** to display the “Program Bass” menu. The current bass level is displayed.

“Program Bass” Menu

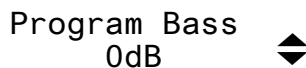

Program Bass
0dB ◀▶

3. Adjust the program bass level with the ▼ and ▲ buttons.

NOTE: While adjusting the program bass level, the program volume level can be adjusted by turning the **VOLUME** control clockwise to raise the volume, or counterclockwise to lower the volume. When adjusting the volume, the display changes to indicate the volume level.

4. Press **MENU** or **ENTER** to save changes and return to the previous screen.

Set the Program Treble Level

To set the program treble level:

1. Access the “Program Output” menu as described on page 42.
2. Press the ▲ or ▼ buttons until *Treble* is displayed on the LCD and press **ENTER** to display the “Program Treble” menu. The current treble level is displayed.

“Program Treble” Menu

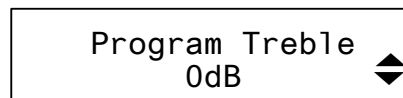

3. Adjust the program treble level with the ▼ and ▲ buttons.

NOTE: While adjusting the program treble level, the program volume level can be adjusted by turning the **VOLUME** control clockwise to raise the volume, or counterclockwise to lower the volume. When adjusting the volume, the display changes to indicate the volume level.

4. Press **MENU** or **ENTER** to save changes and return to the previous screen.

Set the Program Delay

To set the program delay time:

1. Access the “Program Output” menu as described on page 42.
2. Press the ▲ or ▼ buttons until *Prog. Delay* is displayed on the LCD and press **ENTER** to display the “Program Delay” menu. The current delay time is displayed.

“Program Delay” Menu

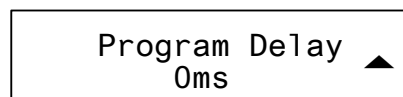

3. Adjust the program delay time with the ▼ and ▲ buttons.
The highest possible program delay time is 85 milliseconds.

NOTE: While adjusting the program delay time, the program volume level can be adjusted by turning the **VOLUME** control clockwise to raise the volume, or counterclockwise to lower the volume. When adjusting the volume, the display changes to indicate the volume level.

4. Press **MENU** or **ENTER** to save changes and return to the previous screen.

**Set the
Program Minimum Volume**

The “Prog. Min Volume” menu is used to set the lowest volume level of the program output.

To set the program minimum volume level:

1. Access the “Program Output” menu as described on page 42.
2. Press the ▲ or ▼ buttons until *Min Volume* is displayed on the LCD and press **ENTER** to display the “Prog Min Volume” menu.

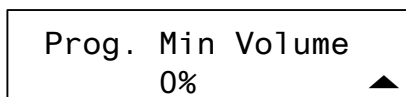
“Prog. Min Volume” Menu

3. Adjust the program minimum volume level with the ▼ and ▲ buttons. The highest program minimum volume level is 50%.

NOTE: While adjusting the program minimum volume level, the program volume level can be adjusted by turning the **VOLUME** control clockwise to raise the volume, or counterclockwise to lower the volume. When adjusting the volume, the display changes to indicate the volume level.

4. Press **MENU** or **ENTER** to save changes and return to the previous screen.

**Set the
Program Maximum Volume**

The “Prog. Max Volume” menu is used to set the highest volume level of the program output.

To set the program maximum volume level:

1. Access the “Program Output” menu as described on page 42.
2. Press the ▲ or ▼ buttons until *Max Volume* is displayed on the LCD and press **ENTER** to display the “Prog. Max Volume” menu.

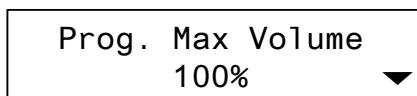
“Prog. Max Volume” Menu

3. Adjust the program maximum volume level with the ▼ and ▲ buttons. The lowest program maximum volume setting is 70%.

NOTE: While adjusting the program maximum volume level, the program volume level can be adjusted by turning the **VOLUME** control clockwise to raise the volume, or counterclockwise to lower the volume. When adjusting the volume, the display changes to indicate the volume level.

4. Press **MENU** or **ENTER** to save changes and return to the previous screen.

**Adjust the
Program Startup Volume**

The “Prog. Startup Vol.” menu is used to establish the program output’s volume level setting when an input is selected.

To adjust the program startup volume level:

1. Access the “Program Output” menu as described on page 42.
2. Press the ▲ or ▼ buttons until *Startup Vol.* is displayed on the LCD and press **ENTER** to display the “Prog. Startup Vol.” menu.

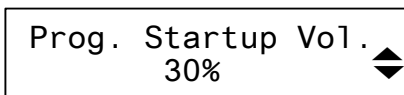
“Prog. Startup Vol.” Menu

- Adjust the program startup volume level with the ▼ and ▲ buttons. The highest program startup volume setting is 100%.

NOTE: While adjusting the program startup volume level, the program volume level can be adjusted by turning the **VOLUME** control clockwise to raise the volume, or counterclockwise to lower the volume. When adjusting the volume, the display changes to indicate the volume level.

- Press **MENU** or **ENTER** to save changes and return to the previous screen.

Set the Stereo/Mono Mode

The “Select Stereo/Mono” menu is used to set the program output mode. The audio sent to the speaker outputs can be set for either stereo or mono. When set to stereo, the audio signal is separated into left and right channels for distribution to left and right speakers or amplifier channels. When set to mono, the audio signal is combined into one signal and sent to both channels for use in larger rooms where stereo separation is not practical.

To set the *Stereo/Mono* mode:

- Access the “Program Output” menu as described on page 42.
- Press the ▲ or ▼ buttons until *Stereo/Mono* is displayed on the LCD and press **ENTER** to display the “Select Stereo/Mono” menu.

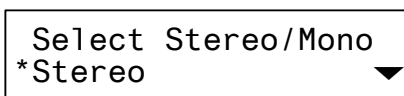
“Select Stereo/Mono” Menu

- Press the ▲ or ▼ buttons until the desired mode is displayed on the LCD and press **ENTER**. The current setting is indicated with an asterisk (*).

NOTE: While adjusting the stereo/mono setting, the program volume level can be adjusted by turning the **VOLUME** control clockwise to raise the volume, or counterclockwise to lower the volume. When adjusting the volume, the display changes to indicate the volume level.

- Press **ENTER** to save changes and return to the “Program Output” menu. To cancel without saving changes, press **MENU**.

Auxiliary Output

The *Auxiliary Output* section of the “Audio Setup” menu is used to set the Aux. 1 Output and Aux. 2 Output source mix, bass, treble, delay, minimum volume, maximum volume, and startup volume settings. The following procedures apply equally to the *Aux. 1 Output* and *Aux. 2 Output* sections of the “Audio Setup” menu.

Access the “Auxiliary Output” Menu

To access the “Aux. 1 Output” or “Aux. 2 Output” menus:

- Access the “Audio Setup” menu as described on page 40.

NOTE: Aux. 2 Output is not present on DMPS-100-C.

2. Press the ▲ or ▼ buttons until the *Aux. 1 Output* or *Aux. 2 Output* is displayed on the LCD and press **ENTER** to display the “Aux. 1 Output” or “Aux. 2 Output” menu.
3. To return to the “Audio Setup” menu, press **MENU**.

**Set the
Auxiliary Output Source Mix**

To set the auxiliary output source mix:

1. Access the “Aux. 1 Output” or “Aux. 2 Output” menu as described above.
2. Press the ▲ or ▼ buttons until *Source Mix* is displayed on the LCD and press **ENTER** to display the “Aux. 1 Source Mix” menu.

“Aux. 1 Source Mix” Menu

Aux. 1 Source Mix
 Aud. Only ▼

3. Press the ▲ or ▼ buttons until the desired setting is displayed on the LCD. The current setting is indicated with an asterisk (*). The following settings are available:
 - *Aud. Only*: Sends the audio signal from the selected source to the **AUX OUT** connector.
 - *Mic. Only*: Sends the microphone input signals to the **AUX OUT** connector.
 - *Mic + Aud*: Sends a mix of the audio signal from the selected source and the microphone input signals to the **AUX OUT** connector.

NOTE: While setting the auxiliary output source mix, the auxiliary volume level can be adjusted by turning the **VOLUME** control clockwise to raise the volume, or counterclockwise to lower the volume. When adjusting the volume, the display changes to indicate the volume level.

4. Press **ENTER** to save changes and return to the previous screen. To cancel without saving changes, press **MENU**.

**Set the
Auxiliary Output Bass Level**

To set the auxiliary output bass level:

1. Access the “Aux. 1 Output” or “Aux. 2 Output” menu as described above.
2. Press the ▲ or ▼ buttons until *Bass* is displayed on the LCD and press **ENTER** to display the “Aux. 1 Bass” menu. The current bass level is displayed.

“Aux. 1 Bass” Menu

Aux. 1 Bass
 0dB ▲▼

3. Adjust the auxiliary output bass level with the ▼ and ▲ buttons.

NOTE: While adjusting the auxiliary output bass level, the auxiliary output volume level can be adjusted by turning the **VOLUME** control clockwise to raise the volume, or counterclockwise to lower the volume.

When adjusting the volume, the display changes to indicate the volume level.

4. Press **MENU** or **ENTER** to save changes and return to the previous screen.

Set the Auxiliary Output Treble Level

To set the auxiliary output treble level:

1. Access the “Aux. 1 Output” or “Aux. 2 Output” menu as described on page 45.
2. Press the ▲ or ▼ buttons until *Treble* is displayed on the LCD and press **ENTER** to display the “Aux. 1 Treble” menu. The current treble level is displayed.

“Aux. 1 Treble” Menu

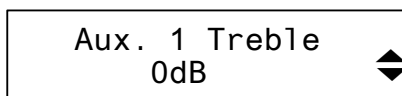

3. Adjust the auxiliary output treble level with the ▼ and ▲ buttons.

NOTE: While adjusting the auxiliary output treble level, the auxiliary output volume level can be adjusted by turning the **VOLUME** control clockwise to raise the volume, or counterclockwise to lower the volume. When adjusting the volume, the display changes to indicate the volume level.

4. Press **MENU** or **ENTER** to save changes and return to the previous screen.

Set the Auxiliary Output Delay Level

To set the auxiliary output delay level:

1. Access the “Aux. 1 Output” or “Aux. 2 Output” menu as described on page 45.
2. Press the ▲ or ▼ buttons until *Aux. 1 Delay* is displayed on the LCD and press **ENTER** to display the “Aux. 1 Delay” menu. The current delay time is displayed.

“Aux. 1 Delay” Menu

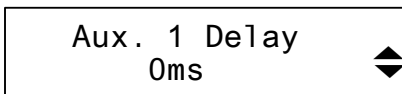

3. Adjust the auxiliary delay time with the ▼ and ▲ buttons. The highest possible auxiliary delay time is 85 milliseconds.

NOTE: While adjusting the auxiliary output delay level, the auxiliary output volume level can be adjusted by turning the **VOLUME** control clockwise to raise the volume, or counterclockwise to lower the volume. When adjusting the volume, the display changes to indicate the volume level.

4. Press **MENU** or **ENTER** to save changes and return to the previous screen.

**Set the Auxiliary Output
Minimum Volume**

The auxiliary output minimum volume control is used to set the lowest volume level of the auxiliary output.

To set the auxiliary output minimum volume level:

1. Access the “Aux. 1 Output” or “Aux. 2 Output” menu as described on page 45.
2. Press the ▲ or ▼ buttons until *Min Volume* is displayed on the LCD and press **ENTER** to display the “Aux. 1 Min Volume” menu.

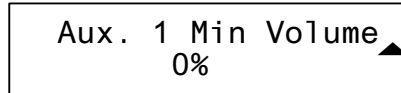
“Aux. 1 Min Volume” Menu

3. Adjust the auxiliary output minimum volume level with the ▼ and ▲ buttons. The highest auxiliary output minimum volume setting is 50%.

NOTE: While adjusting the auxiliary output minimum volume level, the auxiliary output volume level can be adjusted by turning the **VOLUME** control clockwise to raise the volume, or counterclockwise to lower the volume. When adjusting the volume, the display changes to indicate the volume level.

4. Press **MENU** or **ENTER** to save changes and return to the previous screen.

**Set the Auxiliary Output
Maximum Volume**

The auxiliary output maximum volume control is used to set the highest volume level of the auxiliary output.

To set the auxiliary output maximum volume level:

1. Access the “Aux. 1 Output” or “Aux. 2 Output” menu as described on page 45.
2. Press the ▲ or ▼ buttons until *Max Volume* is displayed on the LCD and press **ENTER** to display the “Aux. 1 Max Volume” menu.

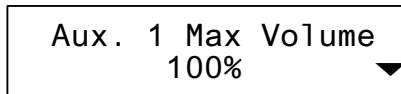
“Aux. 1 Max Volume” Menu

3. Adjust the auxiliary output maximum volume level with the ▼ and ▲ buttons. The lowest auxiliary output maximum volume setting is 70%.

NOTE: While adjusting the auxiliary output maximum volume level, the auxiliary output volume level can be adjusted by turning the **VOLUME** control clockwise to raise the volume, or counterclockwise to lower the volume. When adjusting the volume, the display changes to indicate the volume level.

4. Press **MENU** or **ENTER** to save changes and return to the previous screen.

Adjust the Auxiliary Output Startup Volume

The auxiliary output startup volume control is used to establish the auxiliary output's volume level setting when an input is selected.

To adjust the auxiliary output startup volume level:

1. Access the "Aux. 1 Output" or "Aux. 2 Output" menu as described on page 45.
2. Press the ▲ or ▼ buttons until *Startup Vol.* is displayed on the LCD and press **ENTER** to display the "Aux. 1 Startup Vol." menu.

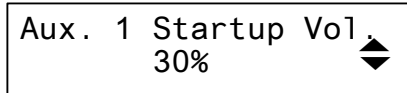
"Aux. 1 Startup Vol." Menu

3. Adjust the auxiliary output startup volume level with the ▼ and ▲ buttons. The highest auxiliary output startup volume setting is 100%.

NOTE: While adjusting the auxiliary output startup volume level, the auxiliary output volume level can be adjusted by turning the **VOLUME** control clockwise to raise the volume, or counterclockwise to lower the volume. When adjusting the volume, the display changes to indicate the volume level.

4. Press **MENU** or **ENTER** to save changes and return to the previous screen.

Input Compensation

The input compensation level of each analog audio input can be set from the DMPS-100/200/300-C's front panel. The line outputs are not affected by changes made to the input compensation level.

Set the Input Compensation Level

To set the input compensation level for an input:

1. Access the "Audio Setup" menu described on page 40.
2. Press the ▲ or ▼ buttons until *Input Compensation* is displayed on the LCD and press **ENTER** to display the "Input Compensation" menu.

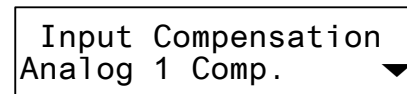
"Input Compensation" Menu

3. To select the input to adjust, press the ▲ or ▼ buttons until the desired input is displayed and press **ENTER**. Inputs include *Analog 1 – 5, S/PDIF, ATC, HDMI 1-5, DM 6* and *DM 7*.

NOTE: Not all inputs are present on the DMPS-100-C or DMPS-200-C devices.

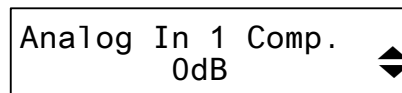
"Analog In 1 Comp" Menu

4. Adjust the input compensation level with the ▼ and ▲ buttons. Compensation can range from -10 dB to 10 dB. A compensation level of 0 dB provides no compensation.

NOTE: While adjusting the compensation level, the master volume level can be adjusted by turning the **VOLUME** control clockwise to raise the volume, or counterclockwise to lower the volume. When adjusting the volume, the display changes to indicate the volume level.

5. Press **MENU** or **ENTER** to save changes and return to the “Input Compensation” menu.
6. Repeat steps 3 through 5 for each input to be adjusted.
7. Press **MENU** to return to the “Audio Setup” menu.

Microphones

The DMPS-100/200/300-C can be connected to several microphones (two for DMPS-100-C, four for DMPS-200-C, and six for DMPS-300-C). Matrix mixing allows for a completely different stereo mix of all microphones at each of the DMPS-100/200/300-C's outputs. The microphone inputs feature switchable gating, compression, and limiters.

Access the “Microphones” Menu

To access the “Microphones” menu:

1. Access the “Audio Setup” menu as described on page 40.
2. Press the ▲ or ▼ buttons until *Microphones* is displayed on the LCD and press **ENTER** to display the “Microphones” menu.
3. To return to the “Audio Setup” menu, press **MENU**.

Set Microphone Input Gating

Microphone input gating can be individually set on each of the microphone inputs. To switch microphone gating on or off:

1. Access the “Microphones” menu as described above.
2. Press the ▲ or ▼ buttons to display each of the Gating choices. Press **ENTER** to display the desired microphone gating control display.

“Mic 1 Gating” Menu

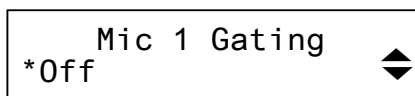

3. Press the ▲ or ▼ buttons to display the desired setting (*On* or *Off*) to enable or disable the gating function. Press **ENTER** to save the setting. The current setting is indicated with an asterisk (*).
4. To exit the “Mic Gating” menu without saving changes, press **MENU**.

Set Microphone Input Compression

Microphone input compression can be individually set on each microphone input. To switch microphone compression on or off:

1. Access the “Microphones” menu as described above.
2. Press the ▲ or ▼ buttons to display each of the Mic Compression choices. Press **ENTER** to display the desired microphone compression menu.

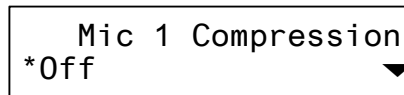
“Mic 1 Compression” Menu

3. Press the ▲ or ▼ buttons to display the desired setting (*On* or *Off*) to enable or disable the compression function. Press **ENTER** to save the setting. The current setting is indicated with an asterisk (*)
4. To exit the “Mic Compression” menu without saving changes, press **MENU**.

Set Microphone Input Limiter

A microphone input limiter can be individually set on each microphone input. To switch the microphone input limiter function on or off:

1. Access the “Microphones” menu as described on page 50.
2. Press the ▲ or ▼ buttons to display each of the *Mic Limiter* choices. Press **ENTER** to display the desired microphone limiter menu.

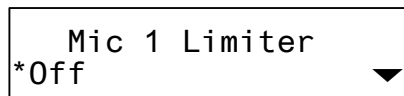
“Mic 1 Limiter” Menu

3. Press the ▲ or ▼ buttons to display the desired setting (*On* or *Off*) to enable or disable the limiter function. Press **ENTER** to save the setting. The current setting is indicated with an asterisk (*)
4. To exit the “Mic Limiter” menu without saving changes, press **MENU**.

Adjust Microphone Input Gain

The gain for each microphone input can be individually set. To adjust the gain of a microphone input:

1. Access the “Microphones” menu as described on page 50.
2. Press the ▲ or ▼ buttons to display each of the *Mic Gain* choices. Press **ENTER** to display the desired microphone gain control display.

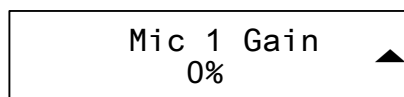
“Mic 1 Gain” Menu

3. Gain can be adjusted between 0% and 100%. Press the ▲ or ▼ buttons until the desired setting is displayed on the LCD and press **ENTER** to save the setting.
4. To exit the “Mic Gain” menu without saving changes, press **MENU**.

Video Setup

The video characteristics of the DMPS-100/200/300-C can be configured from the front panel using the “Video Setup” menu.

Access the “Video Setup” Menu

To access the “Video Setup” menu:

1. Access the “Setup Menu” as described on page 39. Press the ▲ or ▼ buttons until *Video Setup* is displayed on the LCD.
2. Press **ENTER** to display the “Video Setup” menu.

- To exit the “Video Setup” menu, press **MENU**.

Name Video Inputs

To assign the input names:

- Access the “Video Setup” menu as described on the previous page.
- Press the ▲ or ▼ buttons until *Input Names* is displayed on the LCD and press **ENTER** to display the “Sel. Input to Name” menu.

“Sel. Input To Name” Menu

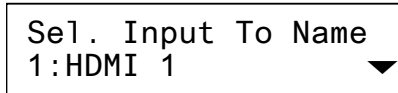

- Press the ▲ or ▼ buttons until the input to be named is displayed on the LCD and press **ENTER**. The cursor is placed after the last character in the input name.

Input Name Change Screen

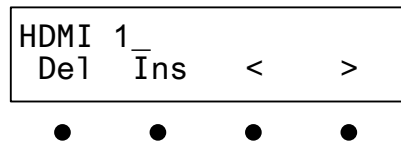

- Turn the **VOLUME** control clockwise or counterclockwise (or press the ▲ or ▼ buttons) to select a new letter (uppercase or lowercase) or number. Move the cursor by pressing the buttons under the < or > symbols. Each input name can be up to 14 characters in length. To delete a character, position the cursor under the character to be deleted and press the button under *Del*. To insert a space, position the cursor where the space is to be inserted and press the button under *Ins*.
- Press **ENTER** to save the new name and return to the “Sel. Input to Name” menu or press **MENU** to cancel the operation and return to the “Sel. Input to Name” menu.
- After all inputs have been named, press **MENU** to return to the “Video Setup” menu.

Select Input Type

To specify the signal types expected by each of the inputs:

- Access the “Video Setup” menu as described on the previous page.
- Press the ▲ or ▼ buttons until *Input Types* is displayed on the LCD and press **ENTER** to display the “Sel. Input Type” menu.

“Sel. Input Type” Menu

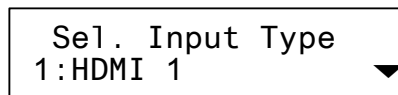

- Press the ▲ or ▼ buttons to select the video input to be set up and press **ENTER**. The current setting is indicated with an asterisk (*).
- Press the ▲ or ▼ buttons until the desired input type is displayed. Depending on the DMPS-100/200/300-C model, input types can include *HDMI 1-2*, *HDMI/VGA 3*, *HDMI/VGA 4*, *HDMI/VGA/COMP*, *DM 1* and *DM 2*.

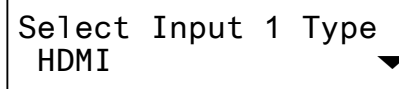
“Select Input 1 Type” Menu

5. Press **ENTER** to save the input type and return to the “Sel. Input Type” menu or press **MENU** to cancel the operation and return to the “Sel. Input Type” menu.
6. After all inputs have been set up, press **MENU** to return to the “Video Setup” menu.

NOTE: For inputs 3, 4, and 5, there is no audio output if the audio input type is set to HDMI, and the video input type is set to something other than HDMI.

Name Video Outputs

The DMPS-100/200/300-C ships with default names assigned to each of the outputs. To change the output names:

1. Access the “Video Setup” menu as described on page 51.
2. Press the ▲ or ▼ buttons until *Output Names* is displayed on the LCD and Press **ENTER** to display the “Sel. Output to Name” menu.

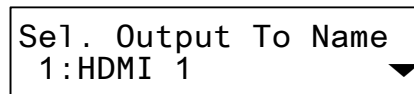
“Sel. Output to Name” Menu

3. Press the ▲ or ▼ buttons until the output to be named is displayed on the LCD and press **ENTER**. The cursor is placed after the last character in the output name.

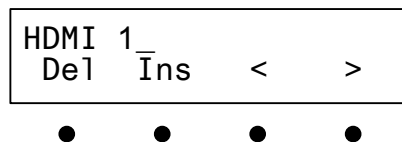
Output Name Change Screen

4. Turn the **VOLUME** control clockwise or counterclockwise (or press the ▲ or ▼ buttons) to select a new letter (uppercase or lowercase) or number. Move the cursor by pressing the buttons under the < or > symbols. Each output name can be up to 14 characters in length. To delete a character, position the cursor under the character to be deleted and press the button under *Del*. To insert a space, position the cursor where the space is to be inserted and press the button under *Ins*.
5. Press **ENTER** to save the new name and return to the “Sel. Output to Name” menu or press **MENU** to cancel the operation and return to the “Sel. Output to Name” menu.
6. After all outputs have been named, press **MENU** to return to the “Video Setup” menu.

Network Setup

The network settings of the DMPS-100/200/300-C can be configured from the front panel using the “Network Setup” menu.

NOTE: Some changes to network settings may require a reboot to take effect. The system automatically reboots when necessary.

Access the “Network Setup” Menu

To access the “Network Setup” menu:

1. Access the “Setup Menu” as described on page 39. Press the ▲ or ▼ buttons until *Network Setup* is displayed on the LCD.
2. Press **ENTER** to display the “Network Setup” menu.
3. To exit the “Network Setup” menu, press **MENU**.

Set the IP Address

The DMPS-100/200/300-C uses TCP/IP for communications between network devices, a PC, and RoomView Help Desk software. The IP address can be manually set or obtained from a DHCP server. For information on using DHCP to obtain an IP address, refer to “Set the DHCP Status” on page 55. To manually set an IP address:

1. Access the “Network Setup” menu as described above.
2. Press the ▲ or ▼ buttons until *IP Address* is displayed on the LCD and press **ENTER** to display the “IP Address” menu. The current IP address is shown.

“IP Address” Menu

IP Address [000] 000. 000. 000



3. Turn the **VOLUME** control clockwise or counterclockwise to select a number in the left-most section of the IP address. Numbers can also be selected by pressing the ▲ or ▼ buttons.
4. Press **ENTER** to move the cursor to the next section of the address. To change a different section, press the button under the section to be changed.
5. Repeat the previous two steps until the entire IP address is set.
6. To save the new address and return to the “Network Setup” menu, move the cursor to the right-most section and press **ENTER**. To cancel the operation and return to the “Network Setup” menu, press **MENU**.

Set the Subnet Mask

The DMPS-100/200/300-C can be set up to use an IP subnet mask for TCP/IP communications. To set the address of the IP subnet mask:

1. Access the Network Setup menu as described above.
2. Press the ▲ or ▼ buttons until *Subnet Mask* is displayed on the LCD and press **ENTER** to display the “Subnet Mask” menu. The current subnet mask IP address is shown.

“Subnet Mask” Menu

Subnet Mask [000] 000. 000. 000



3. Turn the **VOLUME** control clockwise or counterclockwise to select a number in the left-most section of the subnet mask IP address. Numbers can also be selected by pressing the ▲ or ▼ buttons.
4. Press **ENTER** to move the cursor to the next section of the address. To change a different section, press the button under the section to be changed.
5. Repeat the previous two steps until the entire subnet mask IP address is set.
6. To save the new address and return to the “Network Setup” menu, move the cursor to the right-most section and press **ENTER**. To cancel the operation and return to the “Network Setup” menu, press **MENU**.

Set the Default Router

The DMPS-100/200/300-C can be set up to use a default router for TCP/IP communications. To set the IP address of the default router:

1. Access the “Network Setup” menu as described on page 54.
2. Press the ▲ or ▼ buttons until *Def. Router* is displayed on the LCD and press **ENTER** to display the “Def. Router” menu. The current IP address of the default router is shown.

“Def. Router” Menu

Def. Router [000] 000. 000. 000



3. Turn the **VOLUME** control clockwise or counterclockwise to select a number in the left-most section of the default router IP address. Numbers can also be selected by pressing the ▲ or ▼ buttons.
4. Press **ENTER** to move the cursor to the next section of the address. To change a different section, press the button under the section to be changed.
5. Repeat the previous two steps until the entire default router IP address is set.
6. To save the new address and return to the “Network Setup” menu, move the cursor to the right-most section and press **ENTER**. To cancel the operation and return to the “Network Setup” menu, press **MENU**.

Set the DHCP Status

The IP address can be obtained from a DHCP server or manually set. For information on manually setting the IP address, refer to “Set the IP Address” on page 54. To use DHCP:

1. Access the “Network Setup” menu as described on page 54.
2. Press the ▲ or ▼ buttons until *DHCP* is displayed on the LCD and press **ENTER** to display the “DHCP” menu.

“DHCP” Menu

*On DHCP

3. Press ▲ and ▼ buttons to toggle between *On* and *Off*. The current setting is indicated with an asterisk (*).
4. To save the setting and return to the “Network Setup” menu, press **ENTER**. To cancel the operation and return to the “Network Setup” menu, press **MENU**.

Set the WINS Mode

The DMPS-100/200/300-C can use a WINS server to obtain an IP address. To use a WINS server:

1. Access the “Network Setup” menu as described on page 54.
2. Press the ▲ or ▼ buttons until *WINS* is displayed on the LCD and press **ENTER** to display the “WINS” menu.

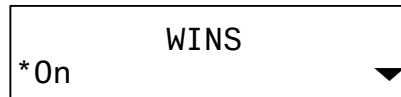
“WINS” Menu

3. Press the ▲ and ▼ buttons to toggle between On and Off. The current setting is indicated with an asterisk (*).
4. To save the setting and return to the “Network Setup” menu, press **ENTER**. To cancel the operation and return to the “Network Setup” menu, press **MENU**.

View and Set the HostName

The DMPS-100/200/300-C can be recognized by its hostname in a networked environment. To set the hostname:

1. Access the “Network Setup” menu as described on page 54.
2. Press the ▲ or ▼ buttons until *HostName* is displayed on the LCD and press **ENTER** to display the current “HostName.”

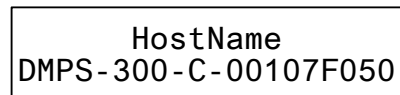
Typical “HostName” Screen

3. Press **ENTER** to change the current name. A cursor is placed at the last character in the name.

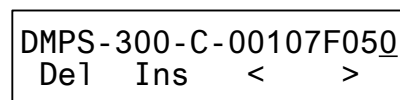
HostName Change Screen

4. Turn the **VOLUME** control clockwise or counterclockwise (or press the ▲ or ▼ buttons) to select a new letter (uppercase or lowercase) or number. Move the cursor by pressing the buttons under the < or > symbols. The hostname can be up to 64 characters in length. To delete a character, position the cursor under the character to be deleted and press the button under *Del*. To insert a space, position the cursor where the space is to be inserted and press the button under *Ins*.
5. To save the new name and return to the “Network Setup” menu, press **ENTER**. To cancel the operation and return to the hostname display, press **MENU**.

View and Set the Domain Name

Some networks may require a domain name to resolve the hostname. To set the domain name:

1. Access the “Network Setup” menu as described on page 54.
2. Press the ▲ or ▼ buttons until *Domain Name* is displayed on the LCD and press **ENTER** to display the “Domain Name” screen. The current domain name (if entered) is displayed. If no domain name is entered, “(none entered)” is displayed.

“Domain Name” Screen

Domain Name
(none entered)

3. Press **ENTER** to change the domain name. A cursor is placed after the last character in the domain name.

Domain Name Change Screen

(none entered)_
Del Ins < >



4. Turn the **VOLUME** control clockwise or counterclockwise (or press the ▲ or ▼ buttons) to select a new letter (uppercase or lowercase) or number. Move the cursor by pressing the buttons under the < or > symbols. The domain name can be up to 64 characters in length. To delete a character, position the cursor under the character to be deleted and press the button under *Del*. To insert a space, position the cursor where the space is to be inserted and press the button under *Ins*.
5. To save the new name and return to the “Network Setup” menu, press **ENTER**. To cancel the operation and return to the domain name display, press **MENU**.

Display the MAC Address

The DMPS-100/200/300-C can display its MAC address. To view the MAC address:

1. Access the “Network Setup” menu as described on page 54.
2. Press the ▲ or ▼ buttons until *MAC Address* is displayed on the LCD and press **ENTER** to display the MAC address.
3. Press **MENU** to return to the “Network Setup” menu.

Control Setup

Basic control system operations can be performed from the DMPS-100/200/300-C front panel using the “Control Setup” menu.

Access the “Control Setup” Menu

To access the “Control Setup” menu:

1. Access the “Setup Menu” as described on page 39. Press the ▲ or ▼ buttons until *Control Setup* is displayed on the LCD.
2. Press **ENTER** to display the “Control Setup” menu.
3. To exit the “Control Setup” menu, press **MENU**.

Change the Backlight Level

The brightness of the LCD's backlight can be adjusted for ease of viewing. To adjust the brightness level from the front panel:

1. Access the "Control Setup" menu as described above.
2. Press the ▲ or ▼ buttons until *Backlight* is displayed on the LCD and press **ENTER** to display the "Select Brightness" menu.

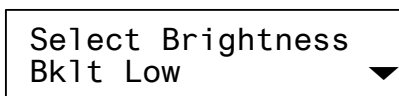
"Select Brightness" Menu

3. Press the ▼ or ▲ buttons to select a brightness level (*Low*, *Medium*, or *High*). An asterisk (*) appears to identify the current setting.
4. To save the desired setting and return to the "Control Setup" menu, press **ENTER**. To cancel the operation and return to the "Control Setup" menu, press **MENU**.

Change the Front Panel Password

The front panel password can be changed from the front panel:

1. Access the "Control Setup" menu as described above.
2. Press the ▲ or ▼ buttons until *Password* is displayed on the LCD and press **ENTER** to display the "Change Passwd" screen. (An existing password is not shown.)

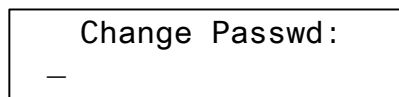
"Change Passwd" Screen

3. Turn the **VOLUME** control to set the first digit (0 – 9) in the password.
4. Press the ▲ and ▼ buttons to move the cursor to each digit position and set each digit with the **VOLUME** control. The maximum password length is 20 digits.
5. To save the new password and return to the "Control Setup" menu, press **ENTER**.
6. To cancel the process without saving any changes, press **MENU**. The display returns to the "Control Setup" menu.

View System Information

Use the front panel to view information about the DMPS-100/200/300-C. Information that can be viewed includes program information, hardware information, network information, and operating system information.

NOTE: This information can also be viewed using Crestron Toolbox. For more information, refer to the Crestron Toolbox help file.

1. Access the "Control Setup" menu as described on page 57.
2. Press the ▲ or ▼ buttons until *Info* is displayed on the LCD and press **ENTER** to display the "Info" menu.

“Info” Menu

- To view program information, press the button under *REMS*.

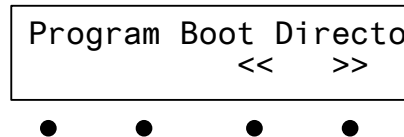
“Program Boot Directory” Screen

- Press the ▲ or ▼ buttons to see other information. If partial information is displayed, press the buttons under the << or >> symbols to view the rest of the information.
- Press the **MENU** button to return to the “Info” menu.
- To view hardware information, press the button under *HW*.

Hardware Information Screen

Press the ▲ or ▼ buttons to see other information. If partial information is displayed, press the buttons under the << or >> symbols to view the rest of the information.

- Press the **MENU** button to return to the “Info” menu.
- To view a list of connected network devices, press the button under *NET*. (If no network devices are connected, *No Network Devices Found* is displayed.)

Connected Network Devices Screen

- Press the ▲ or ▼ buttons to see other network devices. If the information for a network device is partially displayed, press the soft buttons labeled << or >> to view the rest of the information.
- Press the **MENU** button to return to the “Info” menu.
- To view information on the DMPS-100/200/300-C operating system, press the button under *OPS*.

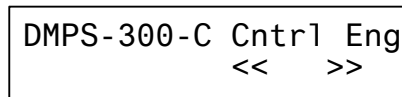
Operating System Information Screen

12. Press the buttons under the symbols << or >> to view the information that cannot fit on the display.
13. Press the **MENU** button to return to the “Info” menu.
14. To return to the “Control Setup” menu, press **MENU**.

Review System Messages

The DMPS-100/200/300-C stores system messages in a message log. To review system messages using the front panel:

1. Access the “Control Setup” menu as described on page 57.
2. Press the ▲ or ▼ buttons until *Messages* is displayed on the LCD and press **ENTER** to display the viewing controls.

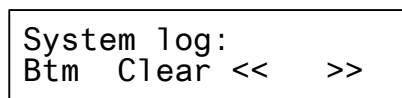
System Message Viewing Controls Screen

3. To scroll through messages in the log, press the ▲ or ▼ buttons.
4. To jump to the last message in the log, press the button under *Btm*.
5. To jump to the beginning of the log, press the button under *Top* (not shown).
6. To view the contents of a message, press the buttons under the symbols << or >>.
7. To erase the contents of the log, press the button under *Clear*.
8. Press **MENU** to return to the “Control Setup” menu.

NOTE: The contents of the message log can also be read and saved using Crestron Toolbox. For more information, refer to the Crestron Toolbox help file.

Set the Date and Time

Use the front panel to set the DMPS-100/200/300-C’s date and time.

1. Access the “Control Setup” menu as described on page 57.
2. Press the ▲ or ▼ buttons until *Time/Date* is displayed on the LCD and press **ENTER** to display the date and time controls.

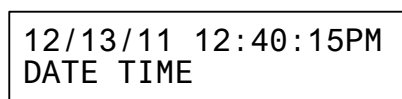
Date and Time Controls Screen

3. To set the date, press the button under *DATE*. The date controls are displayed.

Date Controls Screen

DATE:	12/13/2011
MO	DAY YR



4. To set the month, press the button under *MO*. To set the day, press the button under *DAY*. To set the year, press the button under *YR*. A pair of brackets appears around the selected part of the date.
5. Press the ▲ or ▼ buttons to increase or decrease the value of the selected part of the date.
6. Repeat for each part of the date.
7. Press **ENTER** to store the new date values and return to the “Time/Date” controls or press **MENU** to return to the “Time/Date” controls without saving any changes.
8. To set the time, press the button under *TIME*. The time controls are displayed.

Time Controls Screen

TIME:	12:40:15PM
HR	MIN AM/PM



9. To set the hour, press the button under *HR*. To set the minute, press the button under *MIN*. To set AM or PM, press the button under *AM/PM*. A pair of brackets appears around the selected part of the time.
10. Press the ▲ or ▼ buttons to increase or decrease the value of the selected part of the time.
11. Repeat for each part of the time.
12. Press **ENTER** to store the new time and return to the “Time/Date” controls or press **MENU** to return to the “Time/Date” controls without saving any changes.
13. To return to the “Control Setup” menu, press **MENU**.

NOTE: The date and time can also be set using Crestron Toolbox. For more information, refer to the Crestron Toolbox help file.

Restore Default Settings

The DMPS-100/200/300-C can be restored to its default factory settings from the front panel. Users can select to restore only the audio settings or to restore the audio settings, source names, output names, and function names.

To restore audio settings only:

1. Access the “Control Setup” menu as described on page 57.
2. Press the ▲ or ▼ buttons until *Defaults* is displayed on the LCD and press **ENTER** to display the “Restore Defaults” screen.

“Restore Defaults” Screen (Audio Settings Only)

Restore Defaults Aud. Settings only ▼
--

3. Press the ▲ or ▼ buttons until *Aud. settings only* is displayed on the LCD and press **ENTER**.

“Reset all audio?” Confirmation Screen

Reset all audio? No ▼

4. To restore factory default audio settings, press the ▲ or ▼ buttons until *Yes* is displayed on the LCD and press **ENTER**. To cancel, press the ▲ or ▼ buttons until *No* is displayed on the LCD and press **ENTER**.

To restore all factory default settings:

1. Access the “Restore Defaults” menu as described above.
2. Press the ▲ or ▼ buttons until *All settings* is displayed on the LCD and press **ENTER**. The “Reset all settings?” confirmation screen is displayed.

“Reset all settings?” Confirmation Screen

Reset all settings? No ▼

Press the ▲ or ▼ buttons until *Yes* is displayed on the LCD and press **ENTER** to restore the audio settings, source names, output names, and function names to their factory defaults. To cancel, press the ▲ or ▼ buttons until *No* is displayed on the LCD and press **ENTER**.

To cancel restoring of any default settings:

1. Access the “Restore Defaults” menu as described above.
2. To cancel all of the above restore operations, press the ▲ or ▼ buttons until *Abort* is displayed on the LCD and press **ENTER**. The restore operation is cancelled.

Restore Defaults Screen

Restore Defaults ▲ Abort

Front Panel Lock Control

The DMPS-100/200/300-C’s front panel controls can be locked to prevent operational changes from the buttons on the front of the unit. While locked, the menu can be accessed by pressing the **MENU** button. To display the front panel lock controls:

1. Access the “Control Setup” menu as described on page 57.
2. Press the ▲ or ▼ buttons until *Front Panel* is displayed on the LCD and press **ENTER** to display the “Front Panel Lock” controls.

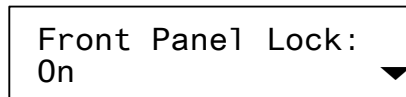
“Front Panel Lock” Controls Screen

3. Press the ▲ or ▼ buttons to toggle between *On* and *Off*. The current setting is indicated with an asterisk (*).
4. Press **ENTER** to save the desired setting and return to the “Control Setup” menu.

Default System Operation

The following describes operation of a default system.

Turn On the System

To turn on the system:

1. Select an output by pressing any of the output buttons:
1 – 4, PROG, AUX 1 or **AUX 2** (**PROG, AUX 1** and **AUX 2** are audio only).
2. Select any of the source inputs by pressing an input button (**1 - 7**).

Turn Off the System

To turn off the system, press the **POWER** button twice.

Adjust the Volume Level

The volume level of the DMPS-100/200/300-C is adjusted with the **VOLUME** control knob. The **VOLUME** control knob only controls the volume parameter that was selected when the *Volume Control* mode was specified.

- To raise the volume: Turn the **VOLUME** control clockwise. The volume level is displayed on the LCD.
- To lower the volume: Turn the **VOLUME** control counterclockwise. The volume level is displayed on the LCD.

Mute Audio

The audio output of the DMPS-100/200/300-C can be muted with the **MUTE** button.

To mute the audio output: Press the button labeled **MUTE**.

To unmute the audio output: Press the **MUTE** button again.

Problem Solving

Troubleshooting

The following table provides corrective action for possible trouble situations. If further assistance is required, please contact a Crestron customer service representative.

DMPS-100/200/300-C Troubleshooting

TROUBLE	POSSIBLE CAUSE(S)	CORRECTIVE ACTION
Unexpected response from control system.	Network devices are not communicating with the control system.	Use Crestron Toolbox to poll the network. Verify network connection to the device.
PWR LED does not illuminate.	Control system is not receiving power.	Verify the power cord is properly attached to the control system and securely plugged into an outlet.
System locks up.	Various.	Press and release front panel HW-R button, then press and hold SW-R button to bypass program and communicate directly with the processor. (Refer to “Troubleshooting Communications” in the Crestron 2-Series Control Systems Reference Guide (Doc. 6256) for more details.
Cresnet device does not respond.	Device not wired correctly.	Verify Cresnet wiring.
	Improper Net ID used.	Verify that device ID matches Net ID in the program.
A/V system device does not respond.	Device is not receiving sufficient power.	User the Crestron Power Calculator to help calculate how much power is needed for the system.
Poor picture quality (RGB).	Cables improperly connected.	Verify that all cables are secure.
	Display device not configured properly.	Configure display device to match output frequency.
Poor picture quality (Video).	Cables improperly connected.	Verify that all cables are secure.

NOTE: If communication cannot be established or the control system is locked-up, refer to “Troubleshooting Communications” in the Crestron 2-Series Control Systems Reference Guide (Doc. 6256).

NOTE: *Passthrough* mode enables Viewport access to any serial controlled device on the network. This aids in troubleshooting by allowing direct communication between the PC and a network device (effectively “passing through” the DMPS-100/200/300-C). For information pertaining to *Passthrough* mode, refer to “Passthrough Mode” in the Crestron 2-Series Control Systems Reference Guide (Doc. 6256).

System Monitor

The System Monitor allows reloading of firmware into the DMPS-100/200/300-C in the event that it cannot be loaded in the normal mode.

If the system does not function, perform the following procedure:

1. Disconnect all Crestron USB devices from the PC.
2. On the DMPS-100/200/300-C, press and release the **HW-R** button. The **MSG** LED starts blinking rapidly four times per second.
3. During the rapid blink of the **MSG** LED, press and release the **SW-R** button. This puts the DMPS-100/200/300-C into *Wait* mode for the next five seconds. During this mode the **MSG** LED blinks slowly, once per second.
4. During *Wait* mode, press and release the **SW-R** button again. The DMPS-100/200/300-C now enters the *Wait Acknowledge* mode for the next five seconds. During this mode the **MSG** LED blinks rapidly four times per second.
5. During *Wait Acknowledge* mode, press and release the **SW-R** button a third time. The DMPS-100/200/300-C enters *Monitor* mode. Once the unit is in *Monitor* mode, the **MSG** LED flashes to indicate *Monitor* mode. The display also indicates the *Monitor* mode.
6. Once the DMPS-100/200/300-C is in *Monitor* mode, connect to the PC using a USB cable.

NOTE: If at any point in the above sequence, one of the timer periods expires without the **SW-R** button being pressed, the unit boots normally, first running the firmware, then loading the application.

NOTE: If the PC does not have the USB driver installed, after connecting the DMPS-100/200/300-C to the PC using the USB cable, a dialog box appears on the PC screen asking for installation of the USB driver. For instructions on how to install the USB driver, refer to the Crestron Toolbox help file.

7. Open Toolbox and start the Text Console (click the  icon). Then, click on the Address Book icon in the lower left corner of the dialog box to open the “Address Book” dialog box.
8. In the “Address Book” dialog box, click the “Add Entry” button and give the new entry a name (such as “System Monitor”).
9. Click the arrow next to the “Device Type” drop down list. A “Warning” dialog box opens stating that this is an advanced feature. Click **OK**, then select *2-Series Control System Monitor* from the drop down list. Make sure to choose **USB** as the “Connection Type”, then click **OK**. The following text appears in the bottom right corner of the “Text Console” dialog box:

```
usb;device 2SeriesCtrlSystemMonitor
```

The following text appears in Toolbox:

```
MPSMNTR>
```

- At the Toolbox prompt, type **erase** and press **Enter**. The following text appears in Toolbox:

Erasing

->25%->50%->75%->100%

Done

- Click the  icon and select **Firmware...** to display the “Firmware” dialog box, then click **Browse**.
- Find and select the correct firmware file (.CUZ or .zip) and click **Open**.
- In the “Firmware” dialog box, click **Send**. A “Confirmation” dialog box opens asking if the right file has been selected. Click **OK** to display the “File Transfer” dialog box.
- When file transfer is completed, a dialog box opens requesting re-connection. Click **OK**, then close the “Firmware” dialog box and re-connect using the normal Address Book entry.

Network Analysis

If Cresnet analysis is required, contact Crestron’s True Blue Support.

Battery Replacement

A Lithium battery is used to power the system clock within the DMPS-100/200/300-C. Under normal conditions, the battery lasts for approximately 10 years. In the event that the clock fails, only an authorized technician should replace it. Refer to caution statement below.

CAUTION: Danger of explosion if battery is incorrectly replaced. Replace only with the same or equivalent type recommended by the manufacturer. Dispose of used batteries according to the manufacturer's instructions.

Check Network Wiring

Use the Right Wire

To ensure optimum performance over the full range of the installation topology, use Crestron Certified Wire only. Failure to do so may incur additional charges if support is required to identify performance deficiencies because of using improper wire.

Calculate Power

CAUTION: Use only Crestron power supplies for Crestron equipment. Failure to do so could cause equipment damage or void the Crestron warranty.

CAUTION: Provide sufficient power to the system. Insufficient power can lead to unpredictable results or damage to the equipment. Use the Crestron Power Calculator to help calculate how much power is needed for the system (www.crestron.com/calculators).

When calculating the length of wire for a particular Cresnet run, the wire gauge and the Cresnet power usage of each network unit to be connected must be taken into consideration. Use Crestron Certified Wire only. If Cresnet devices are to be daisy chained on the run, the Cresnet power usage of each network unit to be daisy chained must be added together to determine the Cresnet power usage of the entire chain. If the unit is run from a Crestron system power supply network port, the Cresnet power usage of that unit is the Cresnet power usage of the entire run. The

wire gauge and the Cresnet power usage of the run should be used in the following equation to calculate the cable length value on the equation's left side.

Cable Length Equation

$$L < \frac{40,000}{R \times P}$$

Where: L = Length of run (or chain) in feet
 R = 6 Ohms (Crestron Certified Wire: 18 AWG (0.75 MM²))
 or 1.6 Ohms (Cresnet HP: 12 AWG (4 MM²))
 P = Cresnet power usage of entire run (or chain)

Make sure the cable length value is less than the value calculated on the right side of the equation. For example, a Cresnet run using 18 AWG Crestron Certified Wire and drawing 20 watts should not have a length of run more than 333 feet (101 meters). If Cresnet HP is used for the same run, its length could extend to 1250 feet (381 meters).

NOTE: All Crestron certified Cresnet wiring must consist of two twisted pairs. One twisted pair is the +24V conductor and the GND conductor and the other twisted pair is the Y conductor and the Z conductor.

Strip and Tin Wire

When daisy chaining Cresnet devices, strip the ends of the wires carefully to avoid nicking the conductors. Twist together the ends of the wires that share a pin on the network connector and tin the twisted connection. Apply solder only to the ends of the twisted wires. Avoid tinning too far up the wires or the end becomes brittle. Insert the tinned connection into the Cresnet connector and tighten the retaining screw. Repeat the procedure for the other three conductors.

Add Hubs

Use of a Cresnet Hub/Repeater (CNXHUB) is advised whenever the number of Cresnet devices on a network exceeds 20 or when the combined total length of Cresnet cable exceeds 3000 feet (914 meters).

Reference Documents

The latest version of all documents mentioned within the guide can be obtained from the Crestron Web site.

List of Related Reference Documents

DOCUMENT TITLE
Crestron 2-Series Control Systems Reference Guide (www.crestron.com/manuals)
Crestron CAT5 Wiring Reference Guide (www.crestron.com/manuals)
DigitalMedia Design Guide (www.crestron.com/dmresources)
Crestron e-Control Reference Guide (www.crestron.com/manuals)
IP Considerations Guide for the IT Professional (www.crestron.com/dmresources)

Further Inquiries

To locate specific information or to resolve questions after reviewing this guide, contact Crestron's True Blue Support at 1-888-CRESTRON [1-888-273-7876] or refer to the listing of Crestron worldwide offices on the Crestron Web site (www.crestron.com/offices) for assistance within a particular geographic region.

To post a question about Crestron products, log onto the Online Help section of the Crestron Web site (www.crestron.com/onlinehelp). First-time users must establish a user account to fully benefit from all available features.

Future Updates

As Crestron improves functions, adds new features and extends the capabilities of the DMPS-100/200/300-C, additional information may be made available as manual updates. These updates are solely electronic and serve as intermediary supplements prior to the release of a complete technical documentation revision.

Check the Crestron Web site periodically for manual update availability and its relevance. Updates are identified as an “Addendum” in the Download column.

Return and Warranty Policies

Merchandise Returns / Repair Service

1. No merchandise may be returned for credit, exchange or service without prior authorization from Crestron. To obtain warranty service for Crestron products, contact an authorized Crestron dealer. Only authorized Crestron dealers may contact the factory and request an RMA (Return Merchandise Authorization) number. Enclose a note specifying the nature of the problem, name and phone number of contact person, RMA number and return address.
2. Products may be returned for credit, exchange or service with a Crestron Return Merchandise Authorization (RMA) number. Authorized returns must be shipped freight prepaid to Crestron, 6 Volvo Drive, Rockleigh, N.J. or its authorized subsidiaries, with RMA number clearly marked on the outside of all cartons. Shipments arriving freight collect or without an RMA number shall be subject to refusal. Crestron reserves the right in its sole and absolute discretion to charge a 15% restocking fee plus shipping costs on any products returned with an RMA.
3. Return freight charges following repair of items under warranty shall be paid by Crestron, shipping by standard ground carrier. In the event repairs are found to be non-warranty, return freight costs shall be paid by the purchaser.

Crestron Limited Warranty

Crestron Electronics, Inc. warrants its products to be free from manufacturing defects in materials and workmanship under normal use for a period of three (3) years from the date of purchase from Crestron, with the following exceptions: disk drives and any other moving or rotating mechanical parts, pan/tilt heads and power supplies are covered for a period of one (1) year; touch screen display and overlay components are covered for 90 days; batteries and incandescent lamps are not covered.

This warranty extends to products purchased directly from Crestron or an authorized Crestron dealer. Purchasers should inquire of the dealer regarding the nature and extent of the dealer's warranty, if any.

Crestron shall not be liable to honor the terms of this warranty if the product has been used in any application other than that for which it was intended or if it has been subjected to misuse, accidental damage, modification or improper installation procedures. Furthermore, this warranty does not cover any product that has had the serial number altered, defaced or removed.

This warranty shall be the sole and exclusive remedy to the original purchaser. In no event shall Crestron be liable for incidental or consequential damages of any kind (property or economic damages inclusive) arising from the sale or use of this equipment. Crestron is not liable for any claim made by a third party or made by the purchaser for a third party.

Crestron shall, at its option, repair or replace any product found defective, without charge for parts or labor. Repaired or replaced equipment and parts supplied under this warranty shall be covered only by the unexpired portion of the warranty.

Except as expressly set forth in this warranty, Crestron makes no other warranties, expressed or implied, nor authorizes any other party to offer any warranty, including any implied warranties of merchantability or fitness for a particular purpose. Any implied warranties that may be imposed by law are limited to the terms of this limited warranty. This warranty statement supersedes all previous warranties.

Crestron software, including without limitation, product development software and product operating system software is licensed to Crestron dealers and Crestron Authorized Independent Programmers (CAIPs) under a limited non-exclusive, non-transferable license pursuant to a separate end-user license agreement. The terms of this end user license agreement can be found on the Crestron Web site at www.crestron.com/legal/software_license_agreement.



Crestron Electronics, Inc.
15 Volvo Drive Rockleigh, NJ 07647
Tel: 888.CRESTRON
Fax: 201.767.7576
www.crestron.com



Operations Guide – DOC. 7219D
(2031708)

03.13

Specifications subject to
change without notice.